

FRANKLIN STEEL plc.

**STEEL
GUIDE**

INDEX

Foreword
The Franklin Steel Group
Product Range
Services Available

Flat Bar

Equal Angle
Unequal Angle
Round Bar
Square Bar

Universal Beams
Universal Columns
Channels

Plate
Floorplate
Open Mesh Flooring

Sheet Hot Rolled
Sheet Cold Reduced
Galvanised Sheet

Square Hollow Section (Cold Formed)
Rectangular Hollow Section (Cold Formed)
Circular Hollow Section (Cold Formed)
Square Hollow Section (Hot Finish)
Rectangular Hollow Section (Hot Finish)
Circular Hollow Section (Hot Finish)

ERW Tube
ERW Squares
ERW Rectangular

Galvanised Tube
Tube Clamps

Reinforcing

Bright Round Bar
Bright Square Bar
Bright Flat Bar
Bright Hexagon Bar

Expanded Metal

Non Ferrous

Consumables

Technical Data

Conditions of Sale

FSS NEWCASTLE

TEL: 0191 499 0222

FAX: 0191 499 0223

EMAIL:

sales@franklinsteelpc.co.uk

FSS DUMFRIES

TEL: 01387 268 877

FAX: 01387 259 101

EMAIL:

dumfries@franklinsteelpc.co.uk

CSS WHITEHAVEN

TEL: 01946 63161

FAX: 01946 691 057

EMAIL:

cumbria@franklinsteelpc.co.uk

FOREWORD

This buyers guide illustrates the extensive product range and services available from the Franklin Steel group and is designed to assist engineers, fabricators and steel buyers.

With over 25 years experience in steel stockholding – we have continually upgraded our services and equipment to meet our customers needs and expectations and maintain our unique position within this industry.

As a result of this we now stock a range of power tools, welding equipment, fasteners etc. associated with the steel fabrication industries to promote our one stop steel shop ethos.

With depots in Tyne & Wear, Cumbria & Dumfriesshire localities we are strategically placed to service the North East, North West, South West Scotland and Border areas.

Decoiling, cutting, profiling, shearing, galvanising and drilling services are all available as required.

We have invested in new machinery, new delivery vehicles and new bespoke computerised systems to provide the highest level of service for our customers.

Product quality and traceability are assured by a Quality System approved to BSEN ISO 9001 at all depots.

BD Phillips
Group Managing Director

FSS NEWCASTLE

TEL: 0191 499 0222

FAX: 0191 499 0223

EMAIL:

sales@franklinsteelplc.co.uk

FSS DUMFRIES

TEL: 01387 268 877

FAX: 01387 259 101

EMAIL:

dumfries@franklinsteelplc.co.uk

CSS WHITEHAVEN

TEL: 01946 63161

FAX: 01946 691 057

EMAIL:

cumbria@franklinsteelplc.co.uk

THE FRANKLIN STEEL plc GROUP

For over 25 years Franklin Steel has provided a first class service and high grade steel products to our clients.

Our on going commitment to quality is clear with all our depots accredited to BSEN ISO9001.

With immediate availability from an extensive onsite stock range, experienced processing capacity and our own delivery fleet offering a fast turnaround including same day distribution, we aim to be the number one steel supplier in Northern England, the North-West, the Borders and Scotland.

This latest edition of our Franklin Steel Pocket Book is a handy reference guide to the range of steel on offer making ordering from us quick and easy.

HEAD OFFICE

Franklin Steel plc,
Patterson Street,
Blaydon Haugh,
Newcastle upon Tyne
Tyne & Wear,
NE21 5TL.

Telephone: (0191) 499 0222
Fax: (0191) 499 0223
Email: sales@franklinsteelplc.co.uk
Website: www.franklinsteelplc.co.uk

CUMBRIA DEPOT

FSS plc T/A CSS Cumbria Steelstock,
William Pit Industrial Estate,
Whitehaven,
Cumbria,
CA28 6AU.

Telephone: (01946) 63161
Fax: (01946) 691 057
Email: cumbria@franklinsteelplc.co.uk
Website: www.franklinsteelplc.co.uk

DUMFRIES DEPOT

Franklin Steel plc (Dumfries)
Dumfries Enterprise Park,
Tinwald Downs Road,
Heathhall,
Dumfries,
DG1 3SJ.

Telephone: (01387) 268877
Fax: (01387) 259 101
Email: dumfries@franklinsteelplc.co.uk
Website: www.franklinsteelplc.co.uk

FSS NEWCASTLE

TEL: 0191 499 0222

FAX: 0191 499 0223

EMAIL:

sales@franklinsteelplc.co.uk

FSS DUMFRIES

TEL: 01387 268 877

FAX: 01387 259 101

EMAIL:

dumfries@franklinsteelplc.co.uk

CSS WHITEHAVEN

TEL: 01946 63161

FAX: 01946 691 057

EMAIL:

cumbria@franklinsteelplc.co.uk

PRODUCT RANGE

An extensive range of materials are readily available ex. stock including:

- ANGLES
- BEAMS
- BRIGHT STEELS
- CHANNELS
- CIRCULAR HOLLOW SECTION
- COIL
- COLUMNS
- CORRUGATED SHEET
- EXPAMET
- FLATS
- FLOORING
- GALVANISED SHEET
- JOISTS
- PLATES
- PROFILES
- REBAR
- REINFORCING
- RECTANGULAR HOLLOW SECTION
- ROUNDS
- SHEET
- SQUARE HOLLOW SECTION
- SQUARES
- STAINLESS STEEL
- TEE SECTIONS
- TUBE FITTINGS
- WELDMESH

ALL DEPOTS ALSO STOCK A COMPREHENSIVE RANGE OF:

- Work Wear/Safety Equipment • Power Tools • Fasteners
- Cutting & Hand Tools • Janitorial Supplies

FSS NEWCASTLE

TEL: 0191 499 0222

FAX: 0191 499 0223

EMAIL:

sales@franklinsteelplc.co.uk

FSS DUMFRIES

TEL: 01387 268 877

FAX: 01387 259 101

EMAIL:

dumfries@franklinsteelplc.co.uk

CSS WHITEHAVEN

TEL: 01946 63161

FAX: 01946 691 057

EMAIL:

cumbria@franklinsteelplc.co.uk

SERVICES AVAILABLE

The following facilities are available in-house & intergroup:-

- **CUTTING EQUIPMENT**
a comprehensive range including semi-automatic and automatic saws
- **CUTTING SERVICE**
available for purchased items to assist clients with collection or use of goods
- **STRAIGHT LINE BURNING**
- **DRILLING**
- **DECOILING**
- **PAINTING**
- **PRIMING**
- **PROFILING**
- **SHOT BLASTING**
- **SHEARING**
- **GALVANISING**

FSS NEWCASTLE

TEL: 0191 499 0222

FAX: 0191 499 0223

EMAIL:

sales@franklinsteelpc.co.uk

FSS DUMFRIES

TEL: 01387 268 877

FAX: 01387 259 101

EMAIL:

dumfries@franklinsteelpc.co.uk

CSS WHITEHAVEN

TEL: 01946 63161

FAX: 01946 691 057

EMAIL:

cumbria@franklinsteelpc.co.uk

MILD STEEL FLAT BAR

CERTIFIED TO BRITISH / EU SPECIFICATIONS

FLAT BAR

SIZE (mm)	kg/m	SIZE (mm)	kg/m	SIZE (mm)	kg/m
10 x 3	0.24	45 x 6	2.12	70 x 3	1.65
13 x 3	0.31	45 x 8	2.83	70 x 5	2.75
13 x 5	0.51	45 x 10	3.53	70 x 6	3.30
13 x 6	0.61	45 x 12	4.24	70 x 8	4.40
16 x 3	0.38	45 x 15	5.30	70 x 10	5.50
16 x 5	0.63	45 x 20	7.07	70 x 12	6.59
16 x 6	0.75	45 x 25	8.83	70 x 15	8.24
16 x 8	1.00	50 x 3	1.18	70 x 20	10.99
16 x 10	1.26	50 x 5	1.96	70 x 25	13.74
20 x 3	0.47	50 x 6	2.36	70 x 30	16.49
20 x 5	0.79	50 x 8	3.14	70 x 50	27.48
20 x 6	0.94	50 x 10	3.93	75 x 3	1.77
20 x 8	1.26	50 x 12	4.71	75 x 4	2.36
20 x 10	1.57	50 x 15	5.89	75 x 5	2.94
20 x 12	1.88	50 x 20	7.85	75 x 6	3.53
25 x 3	0.59	50 x 25	9.81	75 x 8	4.71
25 x 5	0.98	50 x 30	11.78	75 x 10	5.89
25 x 6	1.18	50 x 40	15.70	75 x 12	7.07
25 x 8	1.57	55 x 10	4.32	75 x 15	8.83
25 x 10	1.96	60 x 5	2.36	75 x 20	11.78
25 x 12	2.36	60 x 6	2.83	75 x 25	14.72
25 x 15	2.94	60 x 8	3.77	75 x 30	17.66
25 x 20	3.93	60 x 10	4.71	75 x 50	29.44
30 x 3	0.71	60 x 12	5.65	80 x 3	1.88
30 x 5	1.18	60 x 15	7.07	80 x 5	3.14
30 x 6	1.41	60 x 20	9.42	80 x 6	3.77
30 x 8	1.88	60 x 25	11.78	80 x 8	5.02
30 x 10	2.36	60 x 30	14.13	80 x 10	6.28
30 x 12	2.83	60 x 40	18.84	80 x 12	7.54
30 x 15	3.53	65 x 3	1.53	80 x 15	9.42
30 x 20	4.71	65 x 4	2.04	80 x 20	12.56
30 x 25	5.89	65 x 5	2.55	80 x 25	15.70
35 x 6	1.65	65 x 6	3.06	80 x 30	18.84
40 x 3	0.94	65 x 8	4.08	80 x 40	25.12
40 x 5	1.57	65 x 10	5.10	80 x 50	31.40
40 x 6	1.88	65 x 12	6.12	90 x 6	4.24
40 x 8	2.51	65 x 15	7.65	90 x 8	5.65
40 x 10	3.14	65 x 20	10.21	90 x 10	7.07
40 x 12	3.77	65 x 25	12.76	90 x 12	8.48
40 x 15	4.71	65 x 30	15.31	90 x 15	10.60
40 x 20	6.28	65 x 35	17.86	90 x 20	14.13
40 x 25	7.85	65 x 40	20.41	90 x 25	17.66
40 x 30	9.42	65 x 50	25.51	90 x 30	21.20

FSS NEWCASTLE

TEL: 0191 499 0222

FAX: 0191 499 0223

EMAIL:

sales@franklinsteelpc.co.uk

FSS DUMFRIES

TEL: 01387 268 877

FAX: 01387 259 101

EMAIL:

dumfries@franklinsteelpc.co.uk

CSS WHITEHAVEN

TEL: 01946 63161

FAX: 01946 691 057

EMAIL:

cumbria@franklinsteelpc.co.uk

MILD STEEL FLAT BAR

CERTIFIED TO BRITISH / EU SPECIFICATIONS

SIZE (mm)	kg/m	SIZE (mm)	kg/m	SIZE (mm)	kg/m
100 x 3	2.36	140 x 6	6.59	220 x 10	17.27
100 x 4	3.14	140 x 10	10.99	220 x 12	20.72
100 x 5	3.93	140 x 12	13.19	220 x 15	25.91
100 x 6	4.71	140 x 15	16.49	220 x 20	34.54
100 x 8	6.28	140 x 20	21.98	220 x 25	43.18
100 x 10	7.85	140 x 25	27.48		
100 x 12	9.42			250 x 6	11.78
100 x 15	11.78	150 x 5	5.89	250 x 8	15.70
100 x 20	15.70	150 x 6	7.07	250 x 10	19.63
100 x 25	19.63	150 x 8	9.42	250 x 12	23.55
100 x 30	23.55	150 x 10	11.78	250 x 15	29.44
100 x 35	27.48	150 x 12	14.13	250 x 20	39.25
100 x 40	31.40	150 x 15	17.66	250 x 25	49.06
100 x 45	35.33	150 x 20	23.55		
100 x 50	39.25	150 x 25	29.44	300 x 6	14.13
		150 x 30	35.33	300 x 8	18.84
		150 x 30	35.33	300 x 10	23.55
		150 x 40	47.10	300 x 12	28.26
110 x 5	4.32	150 x 45	52.99	300 x 15	35.33
110 x 6	5.18	150 x 50	58.88	300 x 20	47.10
110 x 8	6.91			300 x 25	58.88
110 x 10	8.64	160 x 6	7.54	300 x 30	70.65
110 x 12	10.36	160 x 10	12.56	300 x 40	94.20
110 x 20	17.27	160 x 12	15.07		
110 x 50	43.18	160 x 15	18.84	350 x 10	27.48
		160 x 20	25.12	350 x 12	32.97
		160 x 25	31.40	350 x 15	41.21
				350 x 20	54.95
120 x 5	4.71	180 x 6	8.48	350 x 25	68.69
120 x 6	5.65	180 x 8	11.30		
120 x 10	9.42	180 x 10	14.13	400 x 10	31.40
120 x 12	11.30	180 x 12	16.96	400 x 12	37.68
120 x 20	18.84	180 x 15	21.20	400 x 15	47.10
120 x 25	23.55	180 x 20	28.26	400 x 20	62.80
		180 x 25	35.33	400 x 25	78.50
130 x 5	5.10	200 x 6	9.42		
130 x 6	6.12	200 x 8	12.56		
130 x 8	8.16	200 x 10	15.70		
130 x 10	10.21	200 x 12	18.84		
130 x 12	12.25	200 x 15	23.55		
130 x 15	15.31	200 x 20	31.40		
130 x 20	20.41	200 x 25	39.25		
130 x 25	25.51				
130 x 50	51.03				

FSS NEWCASTLE

TEL: 0191 499 0222
FAX: 0191 499 0223

EMAIL:

sales@franklinsteelpc.co.uk

FSS DUMFRIES

TEL: 01387 268 877
FAX: 01387 259 101

EMAIL:

dumfries@franklinsteelpc.co.uk

CSS WHITEHAVEN

TEL: 01946 63161
FAX: 01946 691 057

EMAIL:

cumbria@franklinsteelpc.co.uk

EQUAL ANGLES

CERTIFIED TO BRITISH / EU SPECIFICATIONS

SIZE (mm)	Thickness	kg/m	SIZE (mm)	Thickness	kg/m
20 x 20	3	0.88	75 x 75	6	6.82
25 x 25	3	1.11	75 x 75	8	8.96
	5	1.77	75 x 75	10	11.05
30 x 30	3	1.36	80 x 80	6	7.34
	5	2.18	80 x 80	8	9.63
40 x 40	3	1.84	80 x 80	10	11.90
	4	2.42	80 x 80	12	14.05
40 x 40	5	2.97	90 x 90	6	8.30
40 x 40	6	3.52	90 x 90	8	10.90
45 x 45	5	3.38	90 x 90	10	13.40
	6	4.00	90 x 90	12	15.90
50 x 50	3	2.33	100 x 100	8	12.20
	5	3.77	100 x 100	10	15.00
50 x 50	6	4.47	100 x 100	12	17.80
50 x 50	8	5.82	100 x 100	15	21.90
60 x 60	5	4.57	120 x 120	8	14.70
	6	5.42	120 x 120	10	18.20
60 x 60	8	7.09	120 x 120	12	21.60
60 x 60	10	8.69	120 x 120	15	26.60
70 x 70	6	6.38	150 x 150	10	23.00
	8	8.36	150 x 150	12	27.30
70 x 70	10	10.30	150 x 150	15	33.80
			200 x 200	16	48.56
			200 x 200	20	59.90
			200 x 200	24	71.10

UNEQUAL ANGLES

CERTIFIED TO BRITISH / EU SPECIFICATIONS

SIZE (mm)	Thickness	kg/m	SIZE (mm)	Thickness	kg/m
40 x 25	4	1.91	100 x 75	8	10.60
50 x 40	5	3.33	100 x 75	10	13.00
	6	3.93	100 x 75	12	15.40
60 x 30	5	3.37	125 x 75	8	12.20
	6	3.99	125 x 75	10	15.00
60 x 30	6	4.35	125 x 75	12	17.80
65 x 50	5	4.35	150 x 75	10	17.00
	6	5.16	150 x 75	12	20.20
65 x 50	8	6.75	150 x 75	15	24.80
75 x 50	6	5.65	150 x 90	10	18.20
	8	7.39	150 x 90	12	21.60
75 x 50	10	8.90	150 x 90	15	26.60
80 x 60	6	6.37	200 x 100	10	23.00
	8	8.34	200 x 100	12	27.30
80 x 60	8	8.34	200 x 100	15	33.70
100 x 65	7	8.77	200 x 150	12	32.00
100 x 65	8	9.94	200 x 150	15	39.60
100 x 65	10	12.30	200 x 150	18	47.10

FSS NEWCASTLE

TEL: 0191 499 0222

FAX: 0191 499 0223

EMAIL:

sales@franklinsteelplc.co.uk

FSS DUMFRIES

TEL: 01387 268 877

FAX: 01387 259 101

EMAIL:

dumfries@franklinsteelplc.co.uk

CSS WHITEHAVEN

TEL: 01946 63161

FAX: 01946 691 057

EMAIL:

cumbria@franklinsteelplc.co.uk

ROUND BAR

CERTIFIED TO BRITISH / EU SPECIFICATIONS

DIAMETER (mm)	kg/m	DIAMETER (mm)	kg/m
6	0.22	90	49.90
8	0.39	95	56.60
10	0.62	100	61.70
12	0.89	105	68.00
16	1.58	110	74.60
19	2.30	115	81.50
20	2.47	120	88.00
22	2.98	125	96.30
25	3.85	130	104.00
30	5.55	135	112.00
32	6.31	140	121.00
35	7.55	145	130.00
38	8.90	150	139.00
40	9.86	155	148.00
45	12.50	160	158.00
50	15.40	165	168.00
55	18.70	170	178.00
60	22.20	180	200.00
65	26.00	185	211.00
70	30.20	190	224.00
75	34.70	195	234.00
80	38.50	200	247.00
85	44.50	210	272.00

SQUARE BAR

CERTIFIED TO BRITISH / EU SPECIFICATIONS

SIZE (mm)	kg/m	SIZE (mm)	kg/m
6	0.32	32	8.04
8	0.50	35	9.62
10	0.79	40	12.60
12	1.13	45	15.90
15	1.77	50	19.60
16	2.01	60	28.30
19	2.82	70	38.50
20	3.14	80	50.20
22	3.80	90	63.60
25	4.91	100	78.50
30	7.07		

FSS NEWCASTLE

TEL: 0191 499 0222
FAX: 0191 499 0223

EMAIL:

sales@franklinsteelplc.co.uk

FSS DUMFRIES

TEL: 01387 268 877
FAX: 01387 259 101

EMAIL:

dumfries@franklinsteelplc.co.uk

CSS WHITEHAVEN

TEL: 01946 63161
FAX: 01946 691 057

EMAIL:

cumbria@franklinsteelplc.co.uk

UNIVERSAL BEAMS

CERTIFIED TO BRITISH / EU SPECIFICATIONS

DESIGNATION		DIMENSIONS			
Section (mm)	Mass per Metre (kg/m)	Depth of Section (H) (mm)	Width of Section (B) (mm)	Web Thickness (S) (mm)	Flange Thickness (T) (mm)
127 x 76	13	127.0	76.0	4.0	7.6
152 x 89	16	152.4	88.7	4.5	7.7
178 x 102	19	177.8	101.2	4.8	7.9
203 x 102	23	203.2	101.8	5.4	9.3
203 x 133	25	203.2	133.2	5.7	7.8
203 x 133	30	206.8	133.9	6.4	9.6
254 x 102	22	254.0	101.6	5.7	6.8
254 x 102	25	257.2	101.9	6.0	8.4
254 x 102	28	260.4	102.2	6.3	10.0
254 x 146	31	251.4	146.1	6.0	8.6
254 x 146	37	256.0	146.4	6.3	10.9
254 x 146	43	259.6	147.3	7.2	12.7
305 x 102	25	305.1	101.6	5.8	7.0
305 x 102	28	308.7	101.8	6.0	8.8
305 x 102	33	312.7	102.4	6.6	10.8
305 x 127	37	304.4	123.3	7.1	10.7
305 x 127	42	307.2	124.3	8.0	12.1
305 x 127	48	311.0	125.3	9.0	14.0
305 x 165	40	303.4	165.0	6.0	10.2
305 x 165	46	306.6	165.7	6.7	11.8
305 x 165	54	310.4	166.9	7.9	13.7
356 x 127	33	349.0	125.4	6.0	8.5
356 x 127	39	353.4	126.0	6.6	10.7
356 x 171	45	351.4	171.1	7.0	9.7
356 x 171	51	355.0	171.5	7.4	11.5
356 x 171	57	358.0	172.2	8.1	13.0
356 x 171	67	363.4	173.2	9.1	15.7
406 x 140	39	398.0	141.8	6.4	8.6
406 x 140	46	403.2	142.2	6.8	11.2
406 x 178	54	402.6	177.7	7.7	10.9
406 x 178	60	406.4	177.9	7.9	12.8
406 x 178	67	409.4	178.8	8.8	14.3
406 x 178	74	412.8	179.5	9.5	16.0
457 x 152	52	449.8	152.4	7.6	10.9
457 x 152	60	454.6	152.9	8.1	13.3
457 x 152	67	458.0	153.8	9.0	15.0
457 x 152	74	462.0	154.4	9.6	17.0
457 x 152	82	465.8	155.3	10.5	18.9

HEAVY SECTIONS

FSS NEWCASTLE

TEL: 0191 499 0222

FAX: 0191 499 0223

EMAIL:

sales@franklinsteelpc.co.uk

FSS DUMFRIES

TEL: 01387 268 877

FAX: 01387 259 101

EMAIL:

dumfries@franklinsteelpc.co.uk

CSS WHITEHAVEN

TEL: 01946 63161

FAX: 01946 691 057

EMAIL:

cumbria@franklinsteelpc.co.uk

UNIVERSAL BEAMS

CERTIFIED TO BRITISH / EU SPECIFICATIONS

DESIGNATION		DIMENSIONS			
Section (mm)	Mass per Metre (kg/m)	Depth of Section (H) (mm)	Width of Section (B) (mm)	Web Thickness (S) (mm)	Flange Thickness (T) (mm)
457 x 191	67	453.4	189.9	8.5	12.7
457 x 191	74	457.0	190.4	9.0	14.5
457 x 191	82	460.0	191.3	9.9	16.0
457 x 191	89	463.4	191.9	10.5	17.7
457 x 191	98	467.2	192.8	11.4	19.6
533 x 210	82	528.3	208.8	9.6	13.2
533 x 210	92	533.1	209.3	10.1	15.6
533 x 210	101	536.7	210.0	10.8	17.4
533 x 210	109	539.5	210.8	11.6	18.8
533 x 210	122	544.5	211.9	12.7	21.3
610 x 229	101	602.6	227.6	10.5	14.8
610 x 229	113	607.6	228.8	11.1	17.3
610 x 229	125	612.2	229.0	11.9	19.6
610 x 229	140	617.2	230.2	13.1	22.1
610 x 305	149	612.4	304.8	11.8	19.7
610 x 305	179	620.2	307.1	14.1	23.6
610 x 305	238	635.8	311.4	18.4	31.4
610 x 229	113	607.6	228.8	11.1	17.3
610 x 229	125	612.2	229.0	11.9	19.6
610 x 229	140	617.2	230.2	13.1	22.1
610 x 305	149	612.4	304.8	11.8	19.7
610 x 305	179	620.2	307.1	14.1	23.6
610 x 305	238	635.8	311.4	18.4	31.4
686 x 254	125	677.9	253.0	11.7	16.2
686 x 254	140	683.5	253.7	12.4	19.0
686 x 254	152	687.5	254.5	13.2	21.0
686 x 254	170	692.9	255.8	14.5	23.7
762 x 267	134	750.0	264.4	12.0	15.5
762 x 267	147	754.0	265.2	12.8	17.5
762 x 267	173	762.2	266.7	14.3	21.6
762 x 267	197	769.8	268.0	15.6	25.4
838 x 292	176	834.9	291.7	14.0	18.8
838 x 292	194	840.7	292.4	14.7	21.7
838 x 292	226	850.9	293.8	16.1	26.8
914 x 305	201	903.0	303.3	15.1	20.2
914 x 305	224	910.4	304.1	15.9	23.9
914 x 305	253	918.4	305.5	17.3	27.9
914 x 305	289	926.6	307.7	19.5	32.0
914 x 419	343	911.8	418.5	19.4	32.0
914 x 419	388	921.0	420.5	21.4	36.6

FSS NEWCASTLE

TEL: 0191 499 0222
FAX: 0191 499 0223

EMAIL:

sales@franklinsteelplc.co.uk

FSS DUMFRIES

TEL: 01387 268 877
FAX: 01387 259 101

EMAIL:

dumfries@franklinsteelplc.co.uk

CSS WHITEHAVEN

TEL: 01946 63161
FAX: 01946 691 057

EMAIL:

cumbria@franklinsteelplc.co.uk

UNIVERSAL COLUMNS

CERTIFIED TO BRITISH / EU SPECIFICATIONS

DESIGNATION		DIMENSIONS			
Section (mm)	Mass per Metre (kg/m)	Depth of Section (H) (mm)	Width of Section (B) (mm)	Web Thickness (S) (mm)	Flange Thickness (T) (mm)
152 x 152	23.0	152.4	152.2	5.8	6.8
152 x 152	30.0	157.6	152.9	6.5	9.4
152 x 152	37.0	161.8	154.4	8.0	11.5
203 x 203	46.0	203.2	203.6	7.2	11.0
203 x 203	52.0	206.2	204.3	7.9	12.5
203 x 203	60.0	209.6	205.8	9.4	14.2
203 x 203	71.0	215.8	206.4	10.0	17.3
203 x 203	86.0	222.2	209.1	12.7	20.5
254 x 254	73.0	254.1	254.6	8.6	14.2
254 x 254	89.0	260.3	256.3	10.3	17.3
254 x 254	107.0	266.7	258.8	12.8	20.5
254 x 254	132.0	276.3	261.3	15.3	25.3
254 x 254	167.0	289.1	265.2	19.2	31.7
305 x 305	97.0	307.9	305.3	9.9	15.4
305 x 305	118.0	314.5	307.4	12.0	18.7
305 x 305	137.0	320.5	309.2	13.8	21.7
305 x 305	158.0	327.1	311.2	15.8	25.0
305 x 305	198.0	339.9	314.5	19.1	31.4
305 x 305	240.0	352.5	318.4	23.0	37.7
305 x 305	283.0	365.3	322.2	26.8	44.1
356 x 368	129.0	355.6	368.6	10.4	17.5
356 x 368	153.0	362.0	370.5	12.3	20.7
356 x 368	177.0	368.2	372.6	14.4	23.8
356 x 368	202.0	374.6	374.7	16.5	27.0
356 x 406	235.0	381.0	394.8	18.4	30.2
356 x 406	287.0	393.6	399.0	22.6	36.5
356 x 406	340.0	406.4	403.0	26.6	42.9
356 x 406	393.0	419.0	407.0	30.6	49.2
356 x 406	467.0	436.6	412.2	35.8	58.0
356 x 406	551.0	455.6	418.5	42.1	67.5
356 x 406	634.0	474.6	424.0	47.6	77.0

UNIVERSAL BEAM

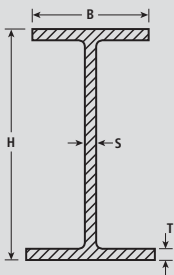

UNIVERSAL COLUMN

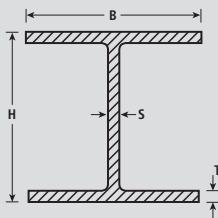

FSS NEWCASTLE

TEL: 0191 499 0222

FAX: 0191 499 0223

EMAIL:

sales@franklinsteelplc.co.uk

FSS DUMFRIES

TEL: 01387 268 877

FAX: 01387 259 101

EMAIL:

dumfries@franklinsteelplc.co.uk

CSS WHITEHAVEN

TEL: 01946 63161

FAX: 01946 691 057

EMAIL:

cumbria@franklinsteelplc.co.uk

PARALLEL FLANGE CHANNELS

CERTIFIED TO BRITISH / EU SPECIFICATIONS

DESIGNATION		DIMENSIONS			
Section (mm)	Mass per Metre (kg/m)	Depth of Section (H) (mm)	Width of Section (B) (mm)	Web Thickness (S) (mm)	Flange Thickness (T) (mm)
100 x 50	10.2	100	50	5.0	8.5
125 x 65	14.8	125	65	5.5	9.5
150 x 75	17.9	150	75	5.5	10.0
150 x 90	23.9	150	90	6.5	12.0
180 x 75	20.3	180	75	6.0	10.5
180 x 90	26.1	180	90	6.5	12.5
200 x 75	23.4	200	75	6.0	12.5
200 x 90	29.7	200	90	7.0	14.0
230 x 75	25.7	230	75	6.5	12.5
230 x 90	32.2	230	90	7.5	14.0
260 x 75	27.6	260	75	7.0	12.0
260 x 90	34.8	260	90	8.0	14.0
300 x 90	41.4	300	90	9.0	15.5
300 x 100	45.5	300	100	9.0	16.5
380 x 100	54.0	380	100	9.5	17.5
430 x 100	64.4	430	100	11.0	19.0

PARALLEL FLANGE CHANNEL

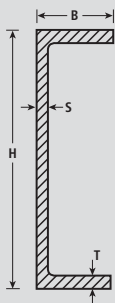

FSS NEWCASTLE

TEL: 0191 499 0222

FAX: 0191 499 0223

EMAIL:

sales@franklinsteelpc.co.uk

FSS DUMFRIES

TEL: 01387 268 877

FAX: 01387 259 101

EMAIL:

dumfries@franklinsteelpc.co.uk

CSS WHITEHAVEN

TEL: 01946 63161

FAX: 01946 691 057

EMAIL:

cumbria@franklinsteelpc.co.uk

TAPERED FLANGE CHANNELS

CERTIFIED TO BRITISH / EU SPECIFICATIONS

DESIGNATION		DIMENSIONS			
Section (mm)	Mass per Metre (kg/m)	Depth of Section (H) (mm)	Width of Section (B) (mm)	Web Thickness (S) (mm)	Flange Thickness (T) (mm)
76 x 38	6.7	76.2	38.1	5.1	6.8

Other sizes available on request

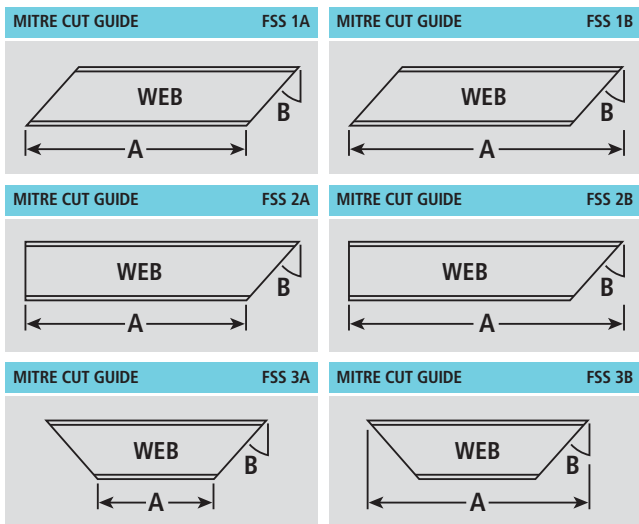

All the above are cut in 'H' position

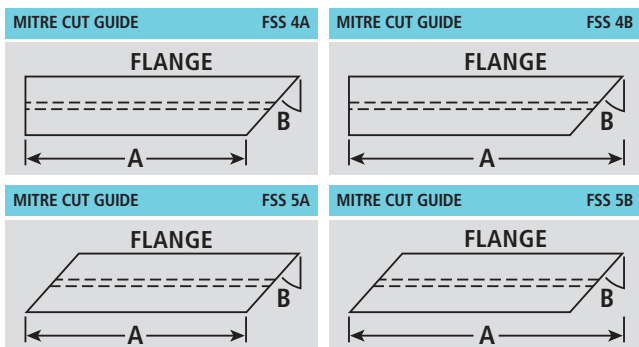

All the above are cut in 'I' position

FSS NEWCASTLE

TEL: 0191 499 0222

FAX: 0191 499 0223

EMAIL:

sales@franklinsteelplc.co.uk

FSS DUMFRIES

TEL: 01387 268 877

FAX: 01387 259 101

EMAIL:

dumfries@franklinsteelplc.co.uk

CSS WHITEHAVEN

TEL: 01946 63161

FAX: 01946 691 057

EMAIL:

cumbria@franklinsteelplc.co.uk

JOISTS

CERTIFIED TO BRITISH / EU SPECIFICATIONS

DESIGNATION		DIMENSIONS			
Section (mm)	Mass per Metre (kg/m)	Depth of Section (H) (mm)	Width of Section (B) (mm)	Web Thickness (S) (mm)	Flange Thickness (T) (mm)
76 x 76	12.8	76.2	76.2	5.1	8.4
102 x 44	7.5	101.6	44.5	4.3	6.1

Other sizes available on request

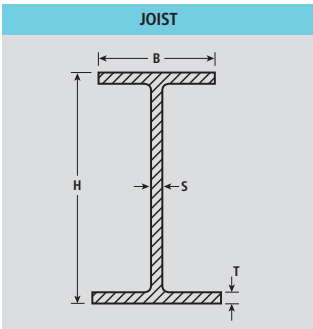

FSS NEWCASTLE

TEL: 0191 499 0222

FAX: 0191 499 0223

EMAIL:

sales@franklinsteelpc.co.uk

FSS DUMFRIES

TEL: 01387 268 877

FAX: 01387 259 101

EMAIL:

dumfries@franklinsteelpc.co.uk

CSS WHITEHAVEN

TEL: 01946 63161

FAX: 01946 691 057

EMAIL:

cumbria@franklinsteelpc.co.uk

MILD STEEL PLATES

CERTIFIED TO BRITISH / EU SPECIFICATIONS

DIMENSIONS			DIMENSIONS		
Length/ Width mm	Thickness mm	Mass per Metre kg/m ²	Length/ Width mm	Thickness mm	Mass per Metre kg/m ²
2000 x 1000	3	23.55	2000 x 1000	12.5	98.13
2500 x 1250	3	23.55	2500 x 1250	12.5	98.13
3000 x 1500	3	23.55	3000 x 1500	12.5	98.13
4000 x 2000	3	23.55	4000 x 2000	12.5	98.13
2000 x 1000	4	31.40	2000 x 1000	15	117.75
2500 x 1250	4	31.40	2500 x 1250	15	117.75
3000 x 1500	4	31.40	3000 x 1500	15	117.75
4000 x 2000	4	31.40	4000 x 2000	15	117.75
2000 x 1000	5	39.25	2000 x 1000	20	157.00
2500 x 1250	5	39.25	2500 x 1250	20	157.00
3000 x 1500	5	39.25	3000 x 1500	20	157.00
4000 x 2000	5	39.25	4000 x 2000	20	157.00
2500 x 1250	6	47.10	2000 x 1000	25	196.25
3000 x 1500	6	47.10	2500 x 1250	25	196.25
3000 x 1525	6	47.10	3000 x 1500	25	196.25
4000 x 2000	6	47.10	4000 x 2000	25	196.25
2000 x 1000	8	62.80	2000 x 1000	30	235.50
2500 x 1250	8	62.80	2500 x 1250	30	235.50
3000 x 1500	8	62.80	3000 x 1500	30	235.50
4000 x 2000	8	62.80	4000 x 2000	30	235.50
2000 x 1000	10	78.50	2000 x 1000	35	274.75
2500 x 1250	10	78.50	2500 x 1250	35	274.75
3000 x 1500	10	78.50	3000 x 1500	35	274.75
4000 x 2000	10	78.50	4000 x 2000	35	274.75
2000 x 1000	12	94.20	2000 x 1000	40	314.00
2500 x 1250	12	94.20	2500 x 1250	40	314.00
3000 x 1500	12	94.20	3000 x 1500	40	314.00
4000 x 2000	12	94.20	4000 x 2000	40	314.00

PLATE, FLOORPLATE & MESH

FSS NEWCASTLE

TEL: 0191 499 0222

FAX: 0191 499 0223

EMAIL:

sales@franklinsteelpc.co.uk

FSS DUMFRIES

TEL: 01387 268 877

FAX: 01387 259 101

EMAIL:

dumfries@franklinsteelpc.co.uk

CSS WHITEHAVEN

TEL: 01946 63161

FAX: 01946 691 057

EMAIL:

cumbria@franklinsteelpc.co.uk

MILD STEEL PLATES

CERTIFIED TO BRITISH / EU SPECIFICATIONS

DIMENSIONS			DIMENSIONS		
Length/ Width mm	Thickness mm	Mass per Metre kg/m ²	Length/ Width mm	Thickness mm	Mass per Metre kg/m ²
2000 x 1000	45	353.25	2000 x 1000	110	863.50
2500 x 1250	45	353.25	2500 x 1250	110	863.50
3000 x 1500	45	353.25	3000 x 1500	110	863.50
4000 x 2000	45	353.25	4000 x 2000	110	863.50
2000 x 1000	50	392.50	2000 x 1000	115	902.75
2500 x 1250	50	392.50	2500 x 1250	115	902.75
3000 x 1500	50	392.50	3000 x 1500	115	902.75
4000 x 2000	50	392.50	4000 x 2000	115	902.75
2000 x 1000	60	471.00	2000 x 1000	120	942.00
2500 x 1250	60	471.00	2500 x 1250	120	942.00
3000 x 1500	60	471.00	3000 x 1500	120	942.00
4000 x 2000	60	471.00	4000 x 2000	120	942.00
2000 x 1000	70	549.50	2000 x 1000	130	1020.50
2500 x 1250	70	549.50	2500 x 1250	130	1020.50
3000 x 1500	70	549.50	3000 x 1500	130	1020.50
4000 x 2000	70	549.50	4000 x 2000	130	1020.50
2000 x 1000	75	588.75	2000 x 1000	135	1059.75
2500 x 1250	75	588.75	2500 x 1250	135	1059.75
3000 x 1500	75	588.75	3000 x 1500	135	1059.75
4000 x 2000	75	588.75	4000 x 2000	135	1059.75
2000 x 1000	80	628.00	2000 x 1000	140	1099.00
2500 x 1250	80	628.00	2500 x 1250	140	1099.00
3000 x 1500	80	628.00	3000 x 1500	140	1099.00
4000 x 2000	80	628.00	4000 x 2000	140	1099.00
2000 x 1000	90	706.50	2000 x 1000	150	1177.50
2500 x 1250	90	706.50	2500 x 1250	150	1177.50
3000 x 1500	90	706.50	3000 x 1500	150	1177.50
4000 x 2000	90	706.50	4000 x 2000	150	1077.50
2000 x 1000	100	785.00			
2500 x 1250	100	785.00			
3000 x 1500	100	785.00			
4000 x 2000	100	785.00			

FSS NEWCASTLE

TEL: 0191 499 0222
FAX: 0191 499 0223

EMAIL:

sales@franklinsteelpc.co.uk

FSS DUMFRIES

TEL: 01387 268 877
FAX: 01387 259 101

EMAIL:

dumfries@franklinsteelpc.co.uk

CSS WHITEHAVEN

TEL: 01946 63161
FAX: 01946 691 057

EMAIL:

cumbria@franklinsteelpc.co.uk

MILD STEEL FLOOR PLATES

CERTIFIED TO BRITISH / EU SPECIFICATIONS

DIMENSIONS			DIMENSIONS		
Length/ Width mm	Thickness O/P mm	Mass per Metre kg/m ²	Length/ Width mm	Thickness O/P mm	Mass per Metre kg/m ²
2000 x 1000	3	26.19	2000 x 1000	10	81.14
2500 x 1250	3	26.19	2500 x 1250	10	81.14
2000 x 1000	4.5	37.97	3000 x 1500	10	81.14
2500 x 1250	4.5	37.97	4000 x 1750	10	81.14
3000 x 1500	4.5	37.97	6000 x 1830	10	81.14
4000 x 1750	4.5	37.97	2000 x 1000	12.5	100.77
2000 x 1000	6	48.70	2500 x 1250	12.5	100.77
2500 x 1250	6	48.70	3000 x 1500	12.5	100.77
3000 x 1500	6	48.70	4000 x 1750	12.5	100.77
4000 x 1750	6	48.70	6000 x 1750	12.5	100.77
4000 x 1830	6	48.70			
2000 x 1000	8	65.44			
2500 x 1250	8	65.44			
3000 x 1500	8	65.44			
4000 x 1750	8	65.44			

Note – the thickness is that of the plain plate exclusive of the raised pattern (typically 1.5m-2.2mm).

FSS NEWCASTLE

TEL: 0191 499 0222

FAX: 0191 499 0223

EMAIL:

sales@franklinsteelplc.co.uk

FSS DUMFRIES

TEL: 01387 268 877

FAX: 01387 259 101

EMAIL:

dumfries@franklinsteelplc.co.uk

CSS WHITEHAVEN

TEL: 01946 63161

FAX: 01946 691 057

EMAIL:

cumbria@franklinsteelplc.co.uk

OPEN MESH FLOORING

CERTIFIED TO BRITISH / EU SPECIFICATIONS



TYPE 41/100 LOAD BEARING BARS AT 41mm PITCH TRANSVERSE BARS AT 100mm PITCH		TYPE 30/100 LOAD BEARING BARS AT 30mm PITCH TRANSVERSE BARS AT 100mm PITCH	
Load Bearing Bar Section	Nominal Weight Kg/m ²	Load Bearing Bar Section	Nominal Weight Kg/m ²
20 x 3mm	15	20 x 3mm	17
25 x 3mm	18	25 x 3mm	23
30 x 3mm	21	30 x 3mm	28
35 x 3mm	25	35 x 3mm	32
40 x 3mm	28	40 x 3mm	36
20 x 5mm	24	20 x 5mm	31
25 x 5mm	29	25 x 5mm	38
30 x 5mm	34	30 x 5mm	45
35 x 5mm	39	35 x 5mm	52
40 x 5mm	45	40 x 5mm	58
50 x 5mm	55	50 x 5mm	73

Fixing clips for the mesh panels can also be supplied.

Standard panel dimensions: 6000mm long x 1000mm wide

Self-colour or Galvanised with Plain or Serrated Bearing Bars

FSS NEWCASTLE

TEL: 0191 499 0222

FAX: 0191 499 0223

EMAIL:

sales@franklinsteelpc.co.uk

FSS DUMFRIES

TEL: 01387 268 877

FAX: 01387 259 101

EMAIL:

dumfries@franklinsteelpc.co.uk

CSS WHITEHAVEN

TEL: 01946 63161

FAX: 01946 691 057

EMAIL:

cumbria@franklinsteelpc.co.uk

HOT ROLLED – MILD STEEL SHEETS

CERTIFIED TO BRITISH / EU SPECIFICATIONS

DIMENSIONS		
Length/Width mm	Thickness mm	Weight kg/m ²
2000 x 1000	1.60	12.56
2500 x 1250	1.60	12.56
3000 x 1500	1.60	12.56
2000 x 1000	2.0	15.70
2500 x 1250	2.0	15.70
3000 x 1500	2.0	15.70
2000 x 1000	2.5	19.63
2500 x 1250	2.5	19.63
3000 x 1500	2.5	19.63

COLD REDUCED – MILD STEEL SHEETS

CERTIFIED TO BRITISH / EU SPECIFICATIONS

DIMENSIONS			DIMENSIONS		
Length/ Width mm	Thickness mm	Weight kg/m ²	Length/ Width mm	Thickness mm	Weight kg/m ²
2000 x 1000	0.8	6.28	2000 x 1000	1.60	12.56
2500 x 1250	0.8	6.28	2500 x 1250	1.60	12.56
3000 x 1500	0.8	6.28	3000 x 1500	1.60	12.56
2000 x 1000	0.9	7.07	2000 x 1000	2.00	15.70
2500 x 1250	0.9	7.07	2500 x 1250	2.00	15.70
3000 x 1500	0.9	7.07	3000 x 1500	2.00	15.70
2000 x 1000	1.0	7.85	2000 x 1000	2.50	19.63
2500 x 1250	1.0	7.85	2500 x 1250	2.50	19.63
3000 x 1500	1.0	7.85	3000 x 1500	2.50	19.63
2000 x 1000	1.20	9.42	2000 x 1000	3.00	23.55
2500 x 1250	1.20	9.42	2500 x 1250	3.00	23.55
3000 x 1500	1.20	9.42	3000 x 1500	3.00	23.55

Decoil to length available

FSS NEWCASTLE

TEL: 0191 499 0222

FAX: 0191 499 0223

EMAIL:

sales@franklinsteelpc.co.uk

FSS DUMFRIES

TEL: 01387 268 877

FAX: 01387 259 101

EMAIL:

dumfries@franklinsteelpc.co.uk

CSS WHITEHAVEN

TEL: 01946 63161

FAX: 01946 691 057

EMAIL:

cumbria@franklinsteelpc.co.uk

www.franklinsteelpc.co.uk

GALVANISED STEEL SHEET

CERTIFIED TO BRITISH / EU SPECIFICATIONS

DIMENSIONS		
Length/Width mm	Thickness mm	Mass per Metre kg/m ²
2000 x 1000	0.6	4.99
2500 x 1250	0.6	4.99
2000 x 1000	0.8	6.56
2500 x 1250	0.8	6.56
3000 x 1250	0.8	6.56
2000 x 1000	1.0	8.13
2500 x 1250	1.0	8.13
3000 x 1250	1.0	8.13
2000 x 1000	1.25	10.09
2500 x 1250	1.25	10.09
3000 x 1250	1.25	10.09
2000 x 1000	1.6	12.84
2500 x 1250	1.6	12.84
3000 x 1250	1.6	12.84
2000 x 1000	2.0	15.98
2500 x 1250	2.0	15.98
3000 x 1250	2.0	15.98
2000 x 1000	2.5	19.95
2500 x 1250	2.5	19.95
2000 x 1000	3.0	23.83
2500 x 1250	3.0	23.83

Galv. Coils and Corrugated Galv. Sheet are also available

FSS NEWCASTLE

TEL: 0191 499 0222
FAX: 0191 499 0223

EMAIL:

sales@franklinsteelplc.co.uk

FSS DUMFRIES

TEL: 01387 268 877
FAX: 01387 259 101

EMAIL:

dumfries@franklinsteelplc.co.uk

CSS WHITEHAVEN

TEL: 01946 63161
FAX: 01946 691 057

EMAIL:

cumbria@franklinsteelplc.co.uk

STRUCTURAL HOLLOW SECTIONS SQUARE - COLD FORMED

CERTIFIED TO BRITISH / EU SPECIFICATIONS

HOLLOW SECTIONS

DIMENSIONS			DIMENSIONS		
Size	Thickness	Mass per Metre	Size	Thickness	Mass per Metre
mm	mm	kg/m ²	mm	mm	kg/m ²
20 x 20	2.0	1.12	100 x 100	3.0	9.10
20 x 20	2.5	1.35	100 x 100	4.0	12.00
25 x 25	2.0	1.43	100 x 100	5.0	14.80
25 x 25	2.5	1.74	100 x 100	6.0	17.60
25 x 25	3.0	2.04	100 x 100	6.3	18.40
30 x 30	2.5	2.14	120 x 120	3.0	11.00
30 x 30	3.0	2.51	120 x 120	4.0	14.50
40 x 40	2.5	2.92	120 x 120	5.0	18.00
40 x 40	3.0	3.45	120 x 120	6.0	21.30
40 x 40	4.0	4.46	120 x 120	6.3	22.30
50 x 50	2.5	3.71	150 x 150	4.0	18.30
50 x 50	3.0	4.30	150 x 150	5.0	22.70
50 x 50	4.0	5.72	150 x 150	6.0	27.00
60 x 60	3.0	5.34	150 x 150	6.3	28.30
60 x 60	4.0	6.97	150 x 150	8.0	35.40
70 x 70	2.5	5.28	150 x 150	10.0	43.60
70 x 70	3.0	6.28	150 x 150	12.5	65.20
70 x 70	3.6	7.46	180 x 180	6.3	34.20
70 x 70	4.0	8.23	180 x 180	8.0	43.00
70 x 70	5.0	10.11	180 x 180	10.0	53.00
80 x 80	3.0	7.22	180 x 180	12.5	65.20
80 x 80	3.6	8.59	180 x 180	16.0	81.40
80 x 80	4.0	9.48	200 x 200	6.3	38.20
80 x 80	5.0	11.70	200 x 200	8.0	48.00
80 x 80	6.0	13.90	200 x 200	10.0	59.30
90 x 90	3.0	8.16	200 x 200	12.5	73.00
90 x 90	3.6	9.72	200 x 200	16.0	91.50
90 x 90	4.0	10.70	250 x 250	6.3	48.10
90 x 90	5.0	13.30	250 x 250	8.0	60.60
90 x 90	6.0	15.70	250 x 250	10.0	75.00
90 x 90	6.3	16.40	250 x 250	12.5	92.60
			250 x 250	16.0	116.60
			300 x 300	10.0	90.70
			300 x 300	12.5	112.30
			300 x 300	16.0	141.70

Other sizes available upon request

FSS NEWCASTLE

TEL: 0191 499 0222

FAX: 0191 499 0223

EMAIL:

sales@franklinsteelplc.co.uk

FSS DUMFRIES

TEL: 01387 268 877

FAX: 01387 259 101

EMAIL:

dumfries@franklinsteelplc.co.uk

CSS WHITEHAVEN

TEL: 01946 63161

FAX: 01946 691 057

EMAIL:

cumbria@franklinsteelplc.co.uk

STRUCTURAL HOLLOW SECTIONS

RECTANGULAR – COLD FORMED

CERTIFIED TO BRITISH / EU SPECIFICATIONS

DIMENSIONS			DIMENSIONS		
Size	Thickness	Mass per Metre	Size	Thickness	Mass per Metre
mm	mm	kg/m ²	mm	mm	kg/m ²
50 x 25	2.0	2.21	120 x 80	4.0	12.00
50 x 25	2.5	2.72	120 x 80	5.0	14.80
50 x 25	3.0	3.22	120 x 80	6.0	17.60
			120 x 80	6.3	18.40
50 x 30	2.5	2.92	150 x 100	4.0	15.10
50 x 30	3.0	3.45	150 x 100	5.0	18.70
50 x 30	4.0	4.46	150 x 100	6.0	22.30
			150 x 100	8.0	29.10
60 x 40	2.5	3.71	160 x 80	4.0	14.50
60 x 40	3.0	4.39	160 x 80	5.0	18.00
60 x 40	4.0	5.72	160 x 80	6.0	21.30
			160 x 80	6.3	22.30
80 x 40	3.0	5.34	200 x 100	5.0	22.70
80 x 40	4.0	6.97	200 x 100	6.0	27.00
80 x 40	5.0	8.54	200 x 100	6.3	28.30
			200 x 100	8.0	35.40
90 x 50	2.5	5.28	200 x 100	10.0	43.60
90 x 50	3.0	6.28	250 x 150	5.0	30.40
90 x 50	3.6	7.46	250 x 150	6.3	38.20
90 x 50	4.0	8.23	250 x 150	8.0	48.00
90 x 50	5.0	10.11	250 x 150	10.0	59.30
			250 x 150	12.5	73.00
100 x 50	3.0	6.75	250 x 150	16.0	91.50
100 x 50	4.0	8.86	300 x 200	6.0	46.00
100 x 50	5.0	10.90	300 x 200	6.3	48.10
100 x 50	6.0	12.90	300 x 200	8.0	60.50
100 x 50	6.3	13.40	300 x 200	10.0	75.00
			300 x 200	12.5	92.60
100 x 60	3.0	7.22	400 x 200	6.0	55.30
100 x 60	3.6	8.59	400 x 200	8.0	73.10
100 x 60	4.0	9.48	400 x 200	10.0	90.70
100 x 60	5.0	11.70	400 x 200	12.0	107.00
100 x 60	6.0	13.90	400 x 200	12.5	112.00
100 x 60	6.3	14.40	450 x 250	10.0	106.00
			450 x 250	12.5	132.00
120 x 60	3.0	8.12	450 x 250	16.0	167.00
120 x 60	3.6	9.72			
120 x 60	4.0	10.70			
120 x 60	5.0	13.30			
120 x 60	6.0	15.70			
120 x 60	6.3	16.40			

Other sizes are available upon request

FSS NEWCASTLE

TEL: 0191 499 0222
FAX: 0191 499 0223

EMAIL:

sales@franklinsteelpc.co.uk

FSS DUMFRIES

TEL: 01387 268 877
FAX: 01387 259 101

EMAIL:

dumfries@franklinsteelpc.co.uk

CSS WHITEHAVEN

TEL: 01946 63161
FAX: 01946 691 057

EMAIL:

cumbria@franklinsteelpc.co.uk

STRUCTURAL HOLLOW SECTIONS CIRCULAR – COLD FORMED

CERTIFIED TO BRITISH / EU SPECIFICATIONS

DIMENSIONS			DIMENSIONS		
Outside Diameter	Thickness	Mass per Metre	Outside Diameter	Thickness	Mass per Metre
mm	mm	kg/m	mm	mm	kg/m
21.3	3.0	1.43	168.3	4.0	16.20
26.9	2.0	1.23	168.3	5.0	20.10
26.9	2.5	1.50	168.3	6.0	24.00
26.9	3.0	1.87	168.3	6.3	25.20
33.7	2.0	1.56	168.3	10.0	39.00
33.7	2.5	1.92	168.3	12.5	48.00
33.7	3.0	2.27	193.7	5.0	23.30
33.7	4.0	2.93	193.7	6.3	29.10
42.4	2.5	2.46	193.7	8.0	36.60
42.4	3.0	2.91	193.7	10.0	45.30
42.4	4.0	3.79	193.7	12.5	55.90
48.3	2.5	2.82	219.1	5.0	26.40
48.3	3.0	3.35	219.1	6.3	33.10
48.3	4.0	4.37	219.1	8.0	41.60
48.3	5.0	5.34	219.1	10.0	51.60
60.3	3.0	4.24	219.1	12.5	63.70
60.3	4.0	5.55	244.5	8.0	46.70
60.3	5.0	6.82	244.5	10.0	57.80
76.1	3.0	5.41	244.5	12.5	71.50
76.1	4.0	7.11	244.5	16.0	90.20
76.1	5.0	8.77	273.0	6.3	41.40
88.9	3.0	6.36	273.0	8.0	52.30
88.9	3.2	6.76	273.0	10.0	64.90
88.9	4.0	8.38	273.0	12.5	80.30
88.9	5.0	10.30	273.0	16.0	101.00
114.3	3.0	8.23	273.0	20.0	125.00
114.3	4.0	10.90	323.9	6.3	49.30
114.3	5.0	13.50	323.9	8.0	62.30
114.3	6.0	16.00	323.9	10.0	77.40
127	3.0	9.17	323.9	12.5	96.00
127	5.0	15.04	323.9	16.0	121.00
139.7	4.0	13.40	323.9	20.0	150.00
139.7	5.0	16.60	355.6	8.0	68.60
139.7	6.0	19.80	355.6	10.0	85.20
139.7	6.3	20.70	355.6	12.5	106.00
139.7	8.0	26.00	355.6	16.0	134.00
139.7	10.0	32.00	355.6	20.0	166.00

FSS NEWCASTLE

TEL: 0191 499 0222

FAX: 0191 499 0223

EMAIL:

sales@franklinsteelplc.co.uk

FSS DUMFRIES

TEL: 01387 268 877

FAX: 01387 259 101

EMAIL:

dumfries@franklinsteelplc.co.uk

CSS WHITEHAVEN

TEL: 01946 63161

FAX: 01946 691 057

EMAIL:

cumbria@franklinsteelplc.co.uk

STRUCTURAL HOLLOW SECTIONS

SQUARE - HOT FINISHED

CERTIFIED TO BRITISH / EU SPECIFICATIONS

DIMENSIONS			DIMENSIONS		
Size	Thickness	Mass per Metre	Size	Thickness	Mass per Metre
mm	mm	kg/m	mm	mm	kg/m
40 x 40	2.5	2.92	90 x 90	3.6	9.72
40 x 40	3.0	3.45	90 x 90	4.0	10.70
40 x 40	4.0	4.46	90 x 90	5.0	13.30
40 x 40	5.0	5.40	90 x 90	6.3	16.40
			90 x 90	8.0	20.40
50 x 50	2.5	3.71	100 x 100	4.0	12.00
50 x 50	3.0	4.39	100 x 100	5.0	14.80
50 x 50	4.0	5.72	100 x 100	6.3	18.40
50 x 50	5.0	6.97	100 x 100	8.0	22.90
50 x 50	6.3	8.49	100 x 100	10.0	27.90
60 x 60	3.0	5.34	120 x 120	5.0	18.00
60 x 60	4.0	6.97	120 x 120	6.3	22.30
60 x 60	5.0	8.54	120 x 120	8.0	27.90
60 x 60	6.3	10.50	120 x 120	10.0	34.20
60 x 60	8.0	12.80	120 x 120	12.5	41.60
70 x 70	3.0	6.28	140 x 140	5.0	21.10
70 x 70	3.6	7.46	140 x 140	6.3	26.30
70 x 70	5.0	10.10	140 x 140	8.0	32.90
70 x 70	6.3	12.50	140 x 140	10.0	40.40
70 x 70	8.0	15.30	140 x 140	12.5	49.50
80 x 80	3.0	7.22	150 x 150	5.0	22.70
80 x 80	3.6	8.59	150 x 150	6.3	28.30
80 x 80	5.0	11.70	150 x 150	8.0	35.40
80 x 80	6.3	14.40	150 x 150	10.0	43.60
80 x 80	8.0	17.80	150 x 150	12.5	53.40

FSS NEWCASTLE

TEL: 0191 499 0222

FAX: 0191 499 0223

EMAIL:

sales@franklinsteelpc.co.uk

FSS DUMFRIES

TEL: 01387 268 877

FAX: 01387 259 101

EMAIL:

dumfries@franklinsteelpc.co.uk

CSS WHITEHAVEN

TEL: 01946 63161

FAX: 01946 691 057

EMAIL:

cumbria@franklinsteelpc.co.uk

STRUCTURAL HOLLOW SECTIONS SQUARE – HOT FINISHED

CERTIFIED TO BRITISH / EU SPECIFICATIONS

DIMENSIONS					
Size	Thickness	Mass per Metre	Size	Thickness	Mass per Metre
mm	mm	kg/m	mm	mm	kg/m
160 x 160	5.0	24.20	300 x 300	6.3	57.90
160 x 160	6.3	30.30	300 x 300	8.0	74.18
160 x 160	8.0	37.90	300 x 300	10.0	90.70
160 x 160	10.0	46.70	300 x 300	12.5	112.00
160 x 160	12.5	57.30	300 x 300	16.0	142.00
180 x 180	5.0	27.40	350 x 350	8.0	85.70
180 x 180	6.3	34.20	350 x 350	10.0	106.00
180 x 180	8.0	43.00	350 x 350	12.5	132.00
180 x 180	10.0	53.00	350 x 350	16.0	167.00
180 x 180	12.5	65.20	400 x 400	10.0	122.00
180 x 180	16.0	81.40	400 x 400	12.5	152.00
200 x 200	5.0	31.18	400 x 400	16.0	192.00
200 x 200	6.3	38.20			
200 x 200	8.0	48.00			
200 x 200	10.0	59.30			
200 x 200	12.5	73.00			
200 x 200	16.0	91.50			
250 x 250	6.3	48.10			
250 x 250	8.0	60.50			
250 x 250	10.0	75.00			
250 x 250	12.5	92.70			
250 x 250	16.0	117.00			

FSS NEWCASTLE

TEL: 0191 499 0222

FAX: 0191 499 0223

EMAIL:

sales@franklinsteelplc.co.uk

FSS DUMFRIES

TEL: 01387 268 877

FAX: 01387 259 101

EMAIL:

dumfries@franklinsteelplc.co.uk

CSS WHITEHAVEN

TEL: 01946 63161

FAX: 01946 691 057

EMAIL:

cumbria@franklinsteelplc.co.uk

STRUCTURAL HOLLOW SECTIONS

RECTANGULAR - HOT FINISHED

CERTIFIED TO BRITISH / EU SPECIFICATIONS

DIMENSIONS			DIMENSIONS		
Size	Thickness	Mass per Metre	Size	Thickness	Mass per Metre
mm	mm	kg/m	mm	mm	kg/m
50 x 30	2.5	2.92	160 x 80	5.0	18.00
50 x 30	3.0	3.45	160 x 80	6.3	22.30
50 x 30	4.0	4.46	160 x 80	8.0	27.90
50 x 30	5.0	5.40	160 x 80	10.0	34.20
			160 x 80	12.5	41.60
60 x 40	2.5	3.71	200 x 100	5.0	22.70
60 x 40	3.0	4.39	200 x 100	6.3	28.30
60 x 40	4.0	5.72	200 x 100	8.0	35.40
60 x 40	5.0	6.97	200 x 100	10.0	43.60
60 x 40	6.3	8.49	200 x 100	12.5	53.40
80 x 40	3.0	5.34	200 x 120	5.0	24.20
80 x 40	4.0	6.97	200 x 120	6.3	30.10
80 x 40	5.0	8.57	200 x 120	8.0	37.60
80 x 40	6.3	10.50	200 x 120	10.0	46.30
90 x 50	3.0	6.28	200 x 150	8.0	41.40
90 x 50	3.6	7.46	200 x 150	10.0	51.00
90 x 50	5.0	10.10			
90 x 50	6.3	12.50	250 x 150	5.0	30.40
90 x 50	8.0	15.30	250 x 150	6.3	38.20
			250 x 150	8.0	48.00
100 x 50	3.0	6.75	250 x 150	10.0	59.30
100 x 50	4.0	8.86	250 x 150	12.5	73.00
100 x 50	5.0	10.90	250 x 150	16.0	91.50
100 x 50	6.3	13.40			
100 x 50	8.0	16.60	300 x 200	6.3	48.10
			300 x 200	8.0	60.30
100 x 60	3.0	7.22	300 x 200	10.0	75.00
100 x 60	3.6	8.59	300 x 200	12.5	92.60
100 x 60	5.0	11.70	300 x 200	16.0	117.00
100 x 60	6.3	14.40			
100 x 60	8.0	17.80	400 x 200	8.0	73.10
			400 x 200	10.0	90.70
120 x 60	3.6	9.72	400 x 200	12.5	112.00
120 x 60	5.0	13.30	400 x 200	16.0	142.00
120 x 60	6.3	16.40			
120 x 60	8.0	20.40	450 x 250	8.0	85.40
			450 x 250	10.0	106.00
120 x 80	5.0	14.80	450 x 250	12.5	132.00
120 x 80	6.3	18.40	450 x 250	16.0	167.00
120 x 80	8.0	22.90			
120 x 80	10.0	27.90	500 x 200	8.0	85.70
			500 x 200	10.0	106.00
150 x 100	5.0	18.70	500 x 200	12.5	132.00
150 x 100	6.3	23.30	500 x 200	16.0	167.00
150 x 100	8.0	29.10			
150 x 100	10.0	35.70	500 x 300	8.0	98.00
150 x 100	12.5	42.60	500 x 300	10.0	122.00
			500 x 300	12.5	152.00
			500 x 300	16.0	192.00

FSS NEWCASTLE

TEL: 0191 499 0222

FAX: 0191 499 0223

EMAIL:

sales@franklinsteelpc.co.uk

FSS DUMFRIES

TEL: 01387 268 877

FAX: 01387 259 101

EMAIL:

dumfries@franklinsteelpc.co.uk

CSS WHITEHAVEN

TEL: 01946 63161

FAX: 01946 691 057

EMAIL:

cumbria@franklinsteelpc.co.uk

STRUCTURAL HOLLOW SECTIONS CIRCULAR – HOT FINISHED

CERTIFIED TO BRITISH / EU SPECIFICATIONS

DIMENSIONS			DIMENSIONS		
Size	Thickness	Mass per Metre	Size	Thickness	Mass per Metre
mm	mm	kg/m	mm	mm	kg/m
21.3	3.0	1.43	219.1	5.0	26.40
26.9	3.0	1.87	219.1	6.3	33.10
33.7	2.6	1.99	219.1	8.0	41.60
33.7	3.0	2.41	219.1	10.0	51.60
33.7	4.0	2.93	219.1	12.5	63.70
42.4	2.6	2.55	244.5	6.3	37.00
42.4	3.0	3.09	244.5	8.0	46.70
42.4	4.0	3.79	244.5	10.0	57.80
42.4	5.0	4.61	244.5	12.5	71.50
48.3	3.0	3.56	244.5	16.0	90.20
48.3	4.0	4.37	273.0	6.3	41.40
48.3	5.0	5.34	273.0	8.0	52.30
60.3	3.0	4.51	273.0	10.0	64.90
60.3	4.0	5.55	273.0	12.5	80.30
60.3	5.0	6.82	273.0	16.0	101.00
76.1	3.0	5.75	323.9	6.3	49.30
76.1	4.0	7.11	323.9	8.0	62.30
76.1	5.0	8.77	323.9	10.0	77.40
88.9	3.0	6.76	323.9	12.5	96.00
88.9	4.0	8.38	323.9	16.0	121.00
88.9	5.0	10.30	355.6	8.0	68.60
88.9	6.3	12.80	355.6	10.0	85.20
114.3	3.0	8.76	355.6	12.5	106.00
114.3	3.6	9.83	355.6	16.0	134.00
114.3	5.0	13.50	406.4	6.3	62.20
114.3	6.3	16.80	406.4	8.0	79.60
139.7	5.0	16.60	406.4	10.0	97.80
139.7	6.3	20.70	406.4	12.5	121.00
139.7	8.0	26.00	406.4	16.0	154.00
139.7	10.0	32.00	457.0	10.0	110.00
168.3	5.0	20.10	457.0	12.5	137.00
168.3	6.3	25.20	457.0	16.0	174.00
168.3	8.0	31.60	508.0	10.0	123.00
168.3	10.0	39.00	508.0	12.5	153.00
168.3	12.5	48.00	508.0	16.0	194.00
193.7	5.0	23.30			
193.7	6.3	29.10			
193.7	8.0	36.60			
193.7	10.0	45.30			
193.7	12.5	55.90			

FSS NEWCASTLE

TEL: 0191 499 0222

FAX: 0191 499 0223

EMAIL:

sales@franklinsteelplc.co.uk

FSS DUMFRIES

TEL: 01387 268 877

FAX: 01387 259 101

EMAIL:

dumfries@franklinsteelplc.co.uk

CSS WHITEHAVEN

TEL: 01946 63161

FAX: 01946 691 057

EMAIL:

cumbria@franklinsteelplc.co.uk

ERW PRECISION WELDED STEEL TUBE

CERTIFIED TO BRITISH / EU SPECIFICATIONS

ERW

CIRCULAR

DIAMETER (mm)	0.7 (mm)	0.8 (mm)	0.9 (mm)	1.0 (mm)	1.2 (mm)	1.5 (mm)	1.6 (mm)	2.0 (mm)
10.00		*	*	*	*	*	*	*
12.70	*	*	*	*	*	*	*	*
15.88		*	*	*	*	*	*	*
19.05	*	*	*	*	*	*	*	*
25.40			*	*	*	*	*	*
31.70			*	*	*	*	*	*
38.10			*	*	*	*	*	*
50.80				*	*	*	*	*
76.20						*	*	*
101.60						*	*	*
139.70						*	*	*

BS6323

SQUARES

SIZE (mm)	0.7 (mm)	0.8 (mm)	0.9 (mm)	1.0 (mm)	1.2 (mm)	1.5 (mm)	1.6 (mm)	2.0 (mm)
12.70 x 12.70	*	*	*	*	*	*	*	*
15.88 x 15.88	*	*	*	*	*	*	*	*
19.05 x 19.05			*	*	*	*	*	*
22.22 x 22.22			*	*	*	*	*	*
25.40 x 25.40			*	*	*	*	*	*
31.70 x 31.70					*	*	*	*
38.10 x 38.10					*	*	*	*
50.80 x 50.80						*	*	*
80.00 x 80.00						*	*	*
100.00 x 100.00						*	*	*

BS6323

FSS NEWCASTLE

TEL: 0191 499 0222

FAX: 0191 499 0223

EMAIL:

sales@franklinsteelplc.co.uk

FSS DUMFRIES

TEL: 01387 268 877

FAX: 01387 259 101

EMAIL:

dumfries@franklinsteelplc.co.uk

CSS WHITEHAVEN

TEL: 01946 63161

FAX: 01946 691 057

EMAIL:

cumbria@franklinsteelplc.co.uk

ERW PRECISION WELDED STEEL TUBE

CERTIFIED TO BRITISH / EU SPECIFICATIONS

RECTANGULAR								
DIAMETER (mm)	0.9 (mm)	1.0 (mm)	1.2 (mm)	1.5 (mm)	1.6 (mm)	2.0 (mm)	2.5 (mm)	3.0 (mm)
20 x 10	*	*	*	*	*	*		
20 x 15	*	*	*	*	*	*		
25 x 10	*	*	*	*	*	*		
25 x 15	*	*	*	*	*	*		
30 x 10	*	*	*	*	*	*		
30 x 15	*	*	*	*	*	*		
30 x 20	*	*	*	*	*	*		
30 x 25	*	*	*	*	*	*		
31.70 x 15.88	*	*	*	*	*	*		
35 x 15	*	*	*	*	*	*		
35 x 20	*	*	*	*	*	*		
38.10 x 19.05	*	*	*	*	*	*		
40 x 10	*	*	*	*	*	*		
40 x 25			*	*	*	*	*	
50 x 10		*	*	*	*	*		
50 x 20			*	*	*	*		
50 x 25			*	*	*	*	*	*
50.80 x 25.40			*	*	*	*	*	*
60 x 25				*	*	*	*	*
63.50 x 25.40				*	*	*	*	*
70 x 25				*	*	*	*	*
76.20 x 25.40				*		*		
76.20 x 50.80				*		*	*	
80 x 25				*		*	*	*
88.90 x 38.10				*		*	*	*
100 x 50				*		*	*	*
150 x 50				*		*	*	*

BS6323

A RANGE OF ERW PERFORATED TUBE & ALUMINISED STEEL TUBE ARE AVAILABLE. CONTACT OUR SALES DEPARTMENT

FSS NEWCASTLE

TEL: 0191 499 0222
FAX: 0191 499 0223

EMAIL:

sales@franklinsteelpc.co.uk

FSS DUMFRIES

TEL: 01387 268 877
FAX: 01387 259 101

EMAIL:

dumfries@franklinsteelpc.co.uk

CSS WHITEHAVEN

TEL: 01946 63161
FAX: 01946 691 057

EMAIL:

cumbria@franklinsteelpc.co.uk

STEEL TUBE TO BS1387

CERTIFIED TO BRITISH / EU SPECIFICATIONS

NOMINAL BORE		APPROX O D	WALL THICKNESS		
			LIGHT	MEDIUM	HEAVY
inches	mm	mm	mm	mm	mm
1/2	15	21.3	2.00	2.65	3.25
3/4	20	26.9	2.30	2.65	3.25
1	25	33.7	2.60	3.25	4.05
1 1/4	32	42.4	2.60	3.25	4.05
1 1/2	40	48.3	2.90	3.25	4.05
2	50	60.3	2.90	3.65	4.50
2 1/2	65	76.1	3.20	3.65	4.50
3	80	88.9	3.20	4.05	4.80
4	100	114.3	3.60	4.50	5.40
5	125	139.7	4.50	4.85	5.40
6	150	165.1	4.50	4.85	5.40
7	175	193.7	4.80	5.40	5.90
8	200	219.1	4.80	5.60	5.90

THIS TUBING IS AVAILABLE IN:

- a range of diameters normally specified as 'Nominal Bore' (NB). See table above.
- galvanised or black finishes
- light, medium and heavy wall
- plain ends or screwed & socketed

Galvanised Handrail Tube can also be supplied with NB: 3/4" – 2 1/2"

A range of fittings for handrail assembly are also available including: Base plates, Connectors, Shanks, Bends and Clamps etc.

FSS NEWCASTLE

TEL: 0191 499 0222

FAX: 0191 499 0223

EMAIL:

sales@franklinsteelpc.co.uk

FSS DUMFRIES

TEL: 01387 268 877

FAX: 01387 259 101

EMAIL:

dumfries@franklinsteelpc.co.uk

CSS WHITEHAVEN

TEL: 01946 63161

FAX: 01946 691 057

EMAIL:

cumbria@franklinsteelpc.co.uk

TUBE CLAMPS

CERTIFIED TO BRITISH / EU SPECIFICATIONS

A diverse range of tube clamps are available for a multitude of tube assembly uses. All clamps are hot dipped galvanised to enhance outdoor usage.

Galvanised tube in lengths of approx. 6.5 mtrs. Galvanised Blackheart malleable iron fittings to BS6681, Grade B32-10 with galvanising to BS EN 1461:1999. Five different size ranges of clamps are available as shown below.

SIZE REFERENCE	NOMINAL BORE	TUBE DIAMETER (mm O/D)
1	3/4"	26.9
2	1"	33.7
3	1 1/4"	42.4
4	1 1/2"	48.3
5	2"	60.3



101

SIZES

- 1
- 2
- 3
- 4
- 5



104

SIZES

- 1
- 2
- 3
- 4
- 5



116

SIZES

- 1
- 2
- 3
- 4
- 5



119

SIZES

- 1
- 2
- 3
- 4
- 5



119

SIZES

- 3
- /
- 4



40°-70°

123

SIZES

- 4

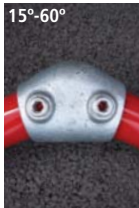

15°-60°

124 (224)

SIZES

- 2
- 3
- 4



125

SIZES

- 1
- 2
- 3
- 4
- 5



30°-45°

126

SIZES

- 2
- 3
- 4



30°-45°

127

SIZES

- 2
- 3
- 4



128

SIZES

- 1
- 2
- 3
- 4
- 5



30°-60°

129

SIZES

- 2
- 3
- 4

FSS NEWCASTLE

TEL: 0191 499 0222

FAX: 0191 499 0223

EMAIL:

sales@franklinsteelpc.co.uk

FSS DUMFRIES

TEL: 01387 268 877

FAX: 01387 259 101

EMAIL:

dumfries@franklinsteelpc.co.uk

CSS WHITEHAVEN

TEL: 01946 63161

FAX: 01946 691 057

EMAIL:

cumbria@franklinsteelpc.co.uk

TUBE CLAMPS

CERTIFIED TO BRITISH / EU SPECIFICATIONS



130

SIZES

- ②
- ③
- ④



131

SIZES

- ①
- ②
- ③
- ④
- ⑤



132

SIZES

- ①
- ②
- ③
- ④
- ⑤



133

SIZES

- ①
- ②
- ③
- ④
- ⑤



134

SIZES

- ②
- ③
- ④

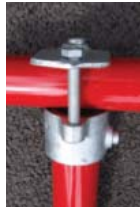

135

SIZES

- ①
- ②
- ④
- ⑤



138

SIZES

- ①
- ②
- ③
- ④



140

SIZES

- ①
- ②
- ③
- ④



143

SIZES

- ①
- ②
- ③
- ④



144

SIZES

- ②
- ③
- ④



145

SIZES

- ②
- ③
- ④



146

SIZES

- ②
- ③
- ④



147

SIZES

- ②
- ③
- ④



148

SIZES

- ①
- ②
- ③
- ④
- ⑤



149

SIZES

- ①
- ②
- ③
- ④
- ⑤

FSS NEWCASTLE

TEL: 0191 499 0222

FAX: 0191 499 0223

EMAIL:

sales@franklinsteelplc.co.uk

FSS DUMFRIES

TEL: 01387 268 877

FAX: 01387 259 101

EMAIL:

dumfries@franklinsteelplc.co.uk

CSS WHITEHAVEN

TEL: 01946 63161

FAX: 01946 691 057

EMAIL:

cumbria@franklinsteelplc.co.uk

TUBE CLAMPS

CERTIFIED TO BRITISH / EU SPECIFICATIONS



150

SIZES

- ②
- ③
- ④



152
(232)

SIZES

- ②
- ③
- ④



153
(201)

SIZES

- ②
- ③
- ④



4°-10°

154
(225)

SIZES

- ②
- ③
- ④



155
(204)

SIZES

- ②
- ③
- ④



156
(219)

SIZES

- ②
- ③
- ④



158

SIZES

- ①
- ②
- ③
- ④
- ⑤



160

SIZES

- ①
- ②
- ③
- ④
- ⑤



161
(219)

SIZES

- ①
- ②
- ③
- ④
- ⑤



161
(219)

SIZES

- ③ / ②
- ④ / ②
- ④ / ③
- ⑤ / ④

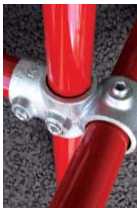

165

SIZES

- ②
- ③
- ④
- ⑤

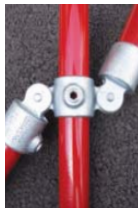

167

SIZES

- ①
- ②
- ③
- ④
- ⑤



167
M

SIZES

- ①
- ②
- ③
- ④
- ⑤



168

SIZES

- ①
- ②
- ③
- ④
- ⑤



168
M

SIZES

- ①
- ②
- ③
- ④
- ⑤

FSS NEWCASTLE

TEL: 0191 499 0222

FAX: 0191 499 0223

EMAIL:

sales@franklinsteelpc.co.uk

FSS DUMFRIES

TEL: 01387 268 877

FAX: 01387 259 101

EMAIL:

dumfries@franklinsteelpc.co.uk

CSS WHITEHAVEN

TEL: 01946 63161

FAX: 01946 691 057

EMAIL:

cumbria@franklinsteelpc.co.uk

TUBE CLAMPS

CERTIFIED TO BRITISH / EU SPECIFICATIONS



169

SIZES

- 1
- 2
- 3
- 4
- 5



169
M

SIZES
N/A



170

SIZES

- 1
- 2
- 3
- 4
- 5



171

SIZES

- 1
- 2
- 3
- 4
- 5



173

SIZES

- 1
- 2
- 3
- 4
- 5



173
F

SIZES

- 1
- 2
- 3
- 4
- 5



173
M

SIZES

- 1
- 2
- 3
- 4
- 5



176

SIZES

- 1
- 2
- 3
- 4
- 5



179

SIZES

- 1
- 2
- 3
- 4



182

SIZES

- 2
- 3
- 4



300

SIZES

*



301

SIZES

*

*Image shows 2 fittings

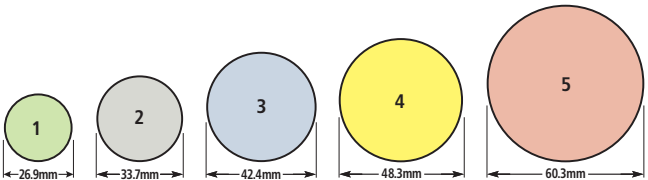

FSS NEWCASTLE

TEL: 0191 499 0222

FAX: 0191 499 0223

EMAIL:

sales@franklinsteelplc.co.uk

FSS DUMFRIES

TEL: 01387 268 877

FAX: 01387 259 101

EMAIL:

dumfries@franklinsteelplc.co.uk

CSS WHITEHAVEN

TEL: 01946 63161

FAX: 01946 691 057

EMAIL:

cumbria@franklinsteelplc.co.uk

REINFORCING

CERTIFIED TO BRITISH / EU SPECIFICATIONS

STANDARD SIZES – 4800mm x 2400mm

Mesh Ref no.	MESH SIZE (mm)		WIRE SIZE (mm)		Weight kg/m ²
	Main	Cross	Main	Cross	

SQUARE MESH

A142	200	200	6	6	2.22
A193	200	200	7	7	3.02
A252	200	200	8	8	3.95
A393	200	200	10	10	6.16

STRUCTURAL MESH

B385	100	200	7	7	4.53
B503	100	200	8	8	5.93
B785	100	200	10	8	8.14
B1131	100	200	12	8	10.90

LONG MESH

C283	100	400	6	5	2.61
C385	100	400	7	5	3.41
C503	100	400	8	5	4.34
C636	100	400	9	6	5.55
C785	100	400	10	6	6.72

WRAPPING MESH

D98	200	200	5	5	1.54
D49	100	100	2.50	2.5	0.77

REINFORCING BAR

CERTIFIED TO BRITISH / EU SPECIFICATIONS

Reference Number	Diameter (mm)	Weight kg/m	Reference Number	Diameter (mm)	Weight kg/m
T8	8	0.395	T20	20	2.466
T10	10	0.616	T25	25	3.854
T12	12	0.888	T32	32	6.313
T16	16	1.579	T40	40	9.864

Available in 6 & 12 metre lengths

We can also supply 'Cut & Bent' material, a range of ancillary products: e.g. wire spacers, plastic spacers, tying wire, double loop ties & tying tools etc. are also readily available in accordance with your requirements.

FSS NEWCASTLE

TEL: 0191 499 0222

FAX: 0191 499 0223

EMAIL:

sales@franklinsteelpc.co.uk

FSS DUMFRIES

TEL: 01387 268 877

FAX: 01387 259 101

EMAIL:

dumfries@franklinsteelpc.co.uk

CSS WHITEHAVEN

TEL: 01946 63161

FAX: 01946 691 057

EMAIL:

cumbria@franklinsteelpc.co.uk

REINFORCEMENT SHAPES

CERTIFIED TO BRITISH / EU SPECIFICATIONS

SHAPE CODE 00
 $L = A$

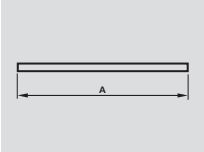

SHAPE CODE 01
 $L = A$

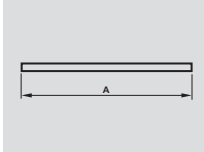

SHAPE CODE 11
 $L = A + (B) - 0.5r - d$

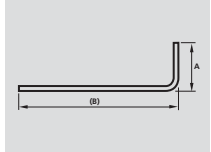

SHAPE CODE 12
 $L = A + (B) - 0.43R - 1.2d$

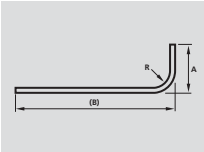

SHAPE CODE 13
 $L = A + 0.57B + (C) - 1.6d$

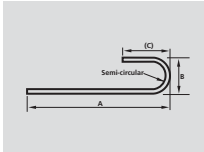

SHAPE CODE 14
 $L = A + (C) - 4d$

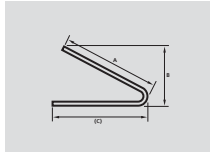

SHAPE CODE 15
 $L = A + (C)$

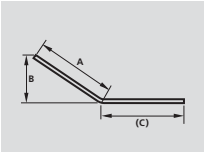

SHAPE CODE 21
 $L = A + B + (C) - r - 2d$

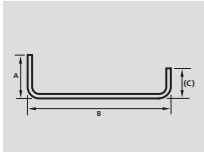

SHAPE CODE 22
 $L = A + B + C + (D) - 1.5r - 3d$

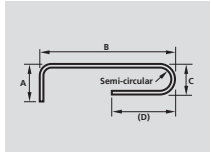

SHAPE CODE 23
 $L = A + B + (C) - r - 2d$

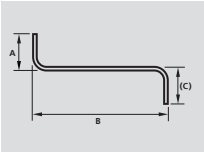

SHAPE CODE 24
 $L = A + B + (C)$

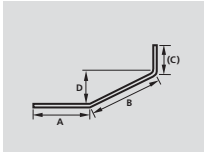

SHAPE CODE 25
 $L = A + B + (E)$

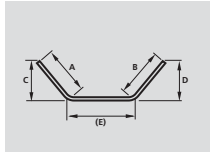

SHAPE CODE 26
 $L = A + B + (C)$

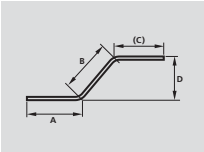

SHAPE CODE 27
 $L = A + B + (C) - 0.5r - d$

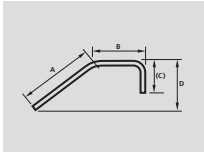

SHAPE CODE 28
 $L = A + B + (C) - 0.5r - d$

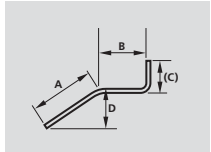

FSS NEWCASTLE
 TEL: 0191 499 0222
 FAX: 0191 499 0223
 EMAIL:
 sales@franklinsteelplc.co.uk

FSS DUMFRIES
 TEL: 01387 268 877
 FAX: 01387 259 101
 EMAIL:
 dumfries@franklinsteelplc.co.uk

CSS WHITEHAVEN
 TEL: 01946 63161
 FAX: 01946 691 057
 EMAIL:
 cumbria@franklinsteelplc.co.uk

REINFORCEMENT SHAPES

CERTIFIED TO BRITISH / EU SPECIFICATIONS

SHAPE CODE 29

$$L = A + B + (C) - r - 2d$$

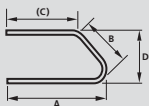

SHAPE CODE 31

$$L = A + B + C + (D) - 1.5r - 3d$$

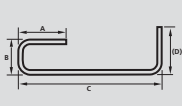

SHAPE CODE 32

$$L = A + B + C + (D) - 1.5r - 3d$$

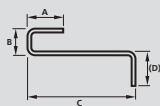

SHAPE CODE 33

$$L = 2A + 1.7B + 2(C) - 4d$$

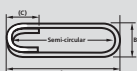

SHAPE CODE 34

$$L = A + B + C + (E) - 0.5r - d$$

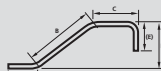

SHAPE CODE 35

$$L = A + B + C + (E) - 0.5r - d$$

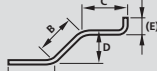

SHAPE CODE 36

$$L = A + B + C + (D) - r - 2d$$

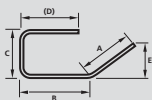

SHAPE CODE 41

$$L = A + B + C + D + (E) - 2r - 4d$$

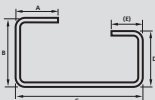

SHAPE CODE 44

$$L = A + B + C + D + (E) - 2r - 4d$$

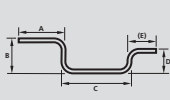

SHAPE CODE 46

$$L = A + 2B + C + (E)$$

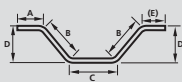

SHAPE CODE 47

$$L = 2A + B + 2(C) + 1.5r - 3d$$



SHAPE CODE 51

$$L = 2(A + B + (C)) - 2.5r - 5d$$

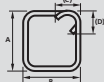

SHAPE CODE 56

$$L = A + B + C + D + 2(E) - 2.5r - 5d$$

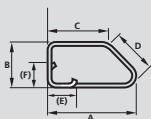

SHAPE CODE 63

$$L = 2A + 3B + 2(C) - 3r - 6d$$

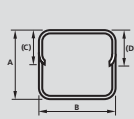

SHAPE CODE 64

$$L = A + B + C + 2D + E + (F) - 3r - 6d$$

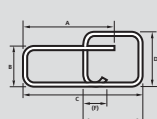

FSS NEWCASTLE

TEL: 0191 499 0222

FAX: 0191 499 0223

EMAIL:

sales@franklinsteelplc.co.uk

FSS DUMFRIES

TEL: 01387 268 877

FAX: 01387 259 101

EMAIL:

dumfries@franklinsteelplc.co.uk

CSS WHITEHAVEN

TEL: 01946 63161

FAX: 01946 691 057

EMAIL:

cumbria@franklinsteelplc.co.uk

REINFORCEMENT SHAPES

CERTIFIED TO BRITISH / EU SPECIFICATIONS

SHAPE CODE 67

$$L = A$$

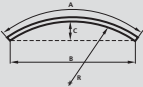

SHAPE CODE 75

$$L = \pi (A - d) + B$$



SHAPE CODE 77

$$L = C\pi (A - d)$$

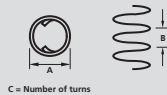

SHAPE CODE 98

$$L = A + 2B + C + (D) - 2r - 4d$$

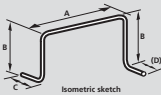

All other shapes are Shape Code 99 and require fully dimensioned sketches

FSS NEWCASTLE

TEL: 0191 499 0222

FAX: 0191 499 0223

EMAIL:

sales@franklinsteelpc.co.uk

FSS DUMFRIES

TEL: 01387 268 877

FAX: 01387 259 101

EMAIL:

dumfries@franklinsteelpc.co.uk

CSS WHITEHAVEN

TEL: 01946 63161

FAX: 01946 691 057

EMAIL:

cumbria@franklinsteelpc.co.uk

TABLE OF MINIMUM DIMENSIONS

CERTIFIED TO BRITISH / EU SPECIFICATIONS

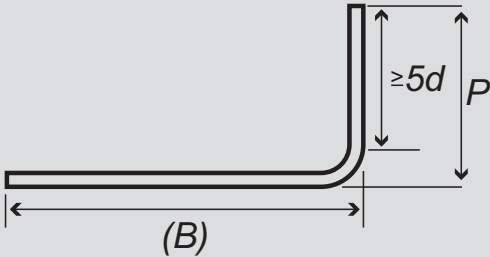

Nominal Size	Minimum Radius for Scheduling	Minimum Diameter for bending former	Minimum End Projection	
			General (min 5d straight)	Links where bend $<150^\circ$ (min 10d straight)
6*	12	24	110	110
8	16	32	115	115
10	20	40	120	130
12	24	48	125	160
16	32	64	130	210
20	70	140	190	290
25	87	175	240	365
32	112	224	305	465
40	140	280	380	580
50*	175	350	475	725

FSS NEWCASTLE

TEL: 0191 499 0222
FAX: 0191 499 0223

EMAIL:

sales@franklinsteelplc.co.uk

FSS DUMFRIES

TEL: 01387 268 877
FAX: 01387 259 101

EMAIL:

dumfries@franklinsteelplc.co.uk

CSS WHITEHAVEN

TEL: 01946 63161
FAX: 01946 691 057

EMAIL:

cumbria@franklinsteelplc.co.uk

BRIGHT STEEL ROUND BAR

CERTIFIED TO BRITISH / EU SPECIFICATIONS

METRIC				IMPERIAL			
Diameter (mm)	Weight kg/m	Diameter (mm)	Weight kg/m	Diameter (inches)	Weight kg/m	Diameter (inches)	Weight kg/m
3	0.056	38	8.880	1/8	0.06	1 1/2	8.93
4	0.100	40	9.840	5/32	0.10	1 9/16	9.68
5	0.150	42	10.850	3/16	0.14	1 5/8	10.48
6	0.222	45	12.460	7/32	0.19	1 3/4	12.16
7	0.302	48	14.200	1/4	0.25	1 7/8	13.95
8	0.390	50	15.400	9/32	0.32	2	15.90
9	0.500	52	16.660	5/16	0.39	2 1/8	17.90
10	0.620	55	18.600	11/32	0.47	2 1/4	20.10
11	0.740	58	20.720	3/8	0.56	2 3/8	22.40
12	0.890	60	22.100	7/16	0.76	2 1/2	24.80
13	1.040	65	26.000	1/2	0.99	2 5/8	27.30
14	1.210	70	30.100	9/16	1.26	2 3/4	30.00
15	1.380	75	34.600	5/8	1.55	2 7/8	32.80
16	1.570	80	39.400	11/16	1.88	3	35.70
17	1.780	85	44.600	3/4	2.23	3 1/4	41.90
18	1.990	90	49.800	7/8	3.04	3 1/2	48.60
19	2.220	95	55.500	15/16	3.49	3 3/4	55.80
20	2.460	100	61.500	1	3.97	4	63.50
22	2.980	110	74.600	1 1/8	5.02	4 1/4	71.70
25	3.850	120	88.800	1 3/16	5.60	4 1/2	80.40
28	4.820	130	104.000	1 1/4	6.20	4 3/4	89.60
30	5.540	140	121.600	1 5/16	6.83	5	99.20
32	6.300	150	138.400	1 3/8	7.50	5 1/2	120.10
35	7.540	160	158.000	1 7/16	8.20	6	143.00

BRIGHT STEEL SQUARE BAR

CERTIFIED TO BRITISH / EU SPECIFICATIONS

METRIC				IMPERIAL			
Size (mm)	Weight kg/m	Size (mm)	Weight kg/m	Size (inches)	Weight kg/m	Size (inches)	Weight kg/m
4	0.125	25	4.90	1/8	0.078	1 1/2	11.37
5	0.197	30	7.05	3/16	0.18	1 3/4	15.50
6	0.28	45	15.90	1/4	0.32	2	20.20
8	0.50	50	19.60	5/16	0.49	2 1/4	25.60
10	0.78	55	23.71	3/8	0.71	2 1/2	31.60
12	1.13	60	28.30	7/16	0.97	3	45.50
14	1.54	65	33.12	1/2	1.26	3 1/2	61.90
15	1.76	70	38.50	5/8	1.97	4	80.90
16	2.01	75	44.10	3/4	2.84	4 1/2	102.30
18	2.54	80	50.20	7/8	3.87	5	126.44
20	3.13	90	63.60	1	5.05	5 1/2	152.99
22	3.80	100	78.12	1 1/4	7.90	6	182.07

FSS NEWCASTLE

TEL: 0191 499 0222
FAX: 0191 499 0223

EMAIL:

sales@franklinsteelplc.co.uk

FSS DUMFRIES

TEL: 01387 268 877
FAX: 01387 259 101

EMAIL:

dumfries@franklinsteelplc.co.uk

CSS WHITEHAVEN

TEL: 01946 63161
FAX: 01946 691 057

EMAIL:

cumbria@franklinsteelplc.co.uk

BRIGHT STEEL FLAT BAR

CERTIFIED TO BRITISH / EU SPECIFICATIONS

IMPERIAL			
Size (inches)	Weight kg/m	Size (inches)	Weight kg/m
1/4 X 3/16	0.20	1 1/2 X 1/8	0.90
3/8 X 1/8	0.20	1 1/2 X 3/16	1.40
3/8 X 3/16	0.40	1 1/2 X 1/4	1.90
3/8 X 1/4	0.50	1 1/2 X 5/16	2.40
1/2 X 1/8	0.30	1 1/2 X 1/2	3.80
1/2 X 3/16	0.50	1 1/2 X 5/8	4.70
1/2 X 3/8	0.90	1 1/2 X 3/4	5.70
5/8 X 1/8	0.40	1 1/2 X 1	7.60
5/8 X 1/4	0.80	2 X 1/8	1.30
5/8 X 5/16	1.00	2 X 3/16	1.90
5/8 X 3/8	1.20	2 X 1/4	2.50
3/4 X 1/8	0.50	2 X 5/16	3.20
3/4 X 3/16	0.70	2 X 1/2	5.10
3/4 X 1/4	0.90	2 X 3/4	7.60
3/4 X 3/8	1.40	2 X 1	10.10
3/4 X 1/2	1.90	2 X 1 1/4	12.70
3/4 X 5/8	2.30	2 X 1 1/2	15.20
1 X 1/8	0.60	2 1/2 X 1/4	3.20
1 X 3/16	0.90	2 1/2 X 3/8	4.70
1 X 1/4	1.30	2 1/2 X 1/2	6.30
1 X 5/16	1.60	2 1/2 X 3/4	9.50
1 X 3/8	1.90	2 1/2 X 1	12.70
1 X 1/2	2.50	2 1/2 X 1 1/4	15.80
1 X 5/8	3.20	2 1/2 X 1 1/2	19.00
1 X 3/4	3.80	2 1/2 X 2	25.30
1 1/4 X 1/4	1.60	3 X 1/8	1.90
1 1/4 X 5/16	2.00	3 X 1/4	3.80
1 1/4 X 3/8	2.40	3 X 1/2	7.60
1 1/4 X 1/2	3.20	3 X 5/8	9.50
1 1/4 X 5/8	4.00	3 X 3/4	11.40
1 1/4 X 3/4	4.70	3 X 1	15.20
1 1/4 X 1	6.30	3 X 1 1/4	19.00

Available in various grades. Other sizes stocked intergroup.
Lengths stocked 3-3.5m randoms

FSS NEWCASTLE

TEL: 0191 499 0222
FAX: 0191 499 0223

EMAIL:

sales@franklinsteelpc.co.uk

FSS DUMFRIES

TEL: 01387 268 877
FAX: 01387 259 101

EMAIL:

dumfries@franklinsteelpc.co.uk

CSS WHITEHAVEN

TEL: 01946 63161
FAX: 01946 691 057

EMAIL:

cumbria@franklinsteelpc.co.uk

BRIGHT STEEL FLAT BAR

CERTIFIED TO BRITISH / EU SPECIFICATIONS

IMPERIAL		IMPERIAL	
Size (inches)	Weight kg/m	Size (inches)	Weight kg/m
3 x 1½	22.80	5 x ¼	6.30
3 x 2	30.40	5 x ⅜	9.50
3½ x ½	13.27	5 x ½	12.70
3½ x ¾	8.84	5 x ⅝	15.80
4 x ¼	5.10	5 x ¾	19.00
4 x ⅜	7.60	5 x 1	25.30
4 x ½	10.10	5 x 1½	37.90
4 x ⅝	12.60	6 x ¼	7.60
4 x ¾	15.20	6 x ⅜	11.40
4 x 1	20.30	6 x ½	15.20
4 x 1¼	25.30	6 x ¾	22.80
4 x 1½	30.40	6 x 1	30.40
4 x 2	40.50		

BRIGHT STEEL HEXAGONS

CERTIFIED TO BRITISH / EU SPECIFICATIONS

IMPERIAL		METRIC	
Size A/F (inches)	Weight kg/m	Size A/F (mm)	Weight kg/m
0.248	0.27	5	0.17
0.312 (5/16)	0.43	10	0.68
0.324	0.46	12	0.98
0.500 (½)	1.09	15	1.53
0.562	1.38	18	2.20
0.600	1.58	20	2.72
0.625 (5/8)	1.71	22	3.28
0.750 (¾)	2.46	25	4.25
0.875 (7/8)	3.35	30	6.11
1.000	4.38	35	8.33
1.125 (1 1/8)	6.84	41	11.43
1.500 (1½)	9.85	50	17.00
1.860	15.10	60	24.40
2.000	17.50	70	33.30

FSS NEWCASTLE

TEL: 0191 499 0222

FAX: 0191 499 0223

EMAIL:

sales@franklinsteelplc.co.uk

FSS DUMFRIES

TEL: 01387 268 877

FAX: 01387 259 101

EMAIL:

dumfries@franklinsteelplc.co.uk

CSS WHITEHAVEN

TEL: 01946 63161

FAX: 01946 691 057

EMAIL:

cumbria@franklinsteelplc.co.uk

WELDED MESH SHEETS AND ROLLS

CERTIFIED TO BRITISH / EU SPECIFICATIONS

MESH

Mesh Size (inches)	Weight kg/ft ²	Mesh Size (inches)	Weight kg/ft ²
1 x 1 x 8G	0.71	3 x 1/2 x 8G	0.83
1 x 1 x 10G	0.44	3 x 1/2 x 10G	0.51
1 x 1 x 12G	0.27	3 x 1/2 x 12G	0.32
1 1/2 x 1 1/2 x 10G	0.29	3 x 1 x 10G	0.29
1 1/2 x 1 1/2 x 12G	0.18	3 x 1 x 12G	0.18
2 x 1 x 8G	0.54	3 x 3 x 6G	0.35
2 x 1 x 10G	0.33	3 x 3 x 8G	0.24
2 x 1 x 12G	0.21	3 x 3 x 10G	0.15
2 x 2 x 6G	0.51	3 x 6 x 6G	0.26
2 x 2 x 8G	0.36	4 x 4 x 10G	0.11
2 x 2 x 10G	0.22		
2 x 2 x 12G	0.14		

Available self colour (copper washed) or galvanised.

Note: for galvanised weld mesh add approx. 7% to above weights

STANDARD PANEL SIZES	STANDARD 60' ROLL WIDTHS
6ft x 3ft	84"
6ft x 4ft	72"
6ft x 12ft	48"
7ft x 12ft	
8ft x 4ft	

Also available:

- Weldmesh hay rack panels
- Chainlink fencing
- Line wire for fencing
- Wire mesh (rolls)
- Security fencing
- Tying wire for fencing.

FSS NEWCASTLE

TEL: 0191 499 0222

FAX: 0191 499 0223

EMAIL:

sales@franklinsteelpc.co.uk

FSS DUMFRIES

TEL: 01387 268 877

FAX: 01387 259 101

EMAIL:

dumfries@franklinsteelpc.co.uk

CSS WHITEHAVEN

TEL: 01946 63161

FAX: 01946 691 057

EMAIL:

cumbria@franklinsteelpc.co.uk

EXPANDED METAL

CERTIFIED TO BRITISH / EU SPECIFICATIONS

A comprehensive range of expanded metal mesh is available in sheet or coil.

The expanded metal can be supplied in either angled or flattened mesh in a variety of metals including: Carbon Steel, Copper, Aluminium, Brass, Stainless Steel, Titanium, Heat Resisting Steel, Nickel or Copper

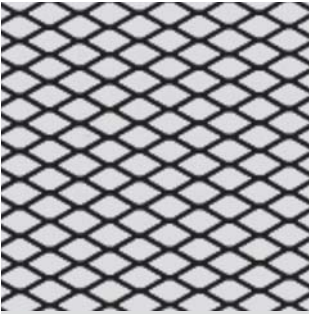
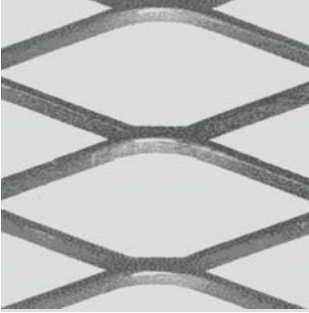

FSS NEWCASTLE

TEL: 0191 499 0222
FAX: 0191 499 0223

EMAIL:
sales@franklinsteelplc.co.uk

FSS DUMFRIES

TEL: 01387 268 877
FAX: 01387 259 101

EMAIL:
dumfries@franklinsteelplc.co.uk

CSS WHITEHAVEN

TEL: 01946 63161
FAX: 01946 691 057

EMAIL:
cumbria@franklinsteelplc.co.uk

EXPANDED METAL – FLATTENED

CERTIFIED TO BRITISH / EU SPECIFICATIONS

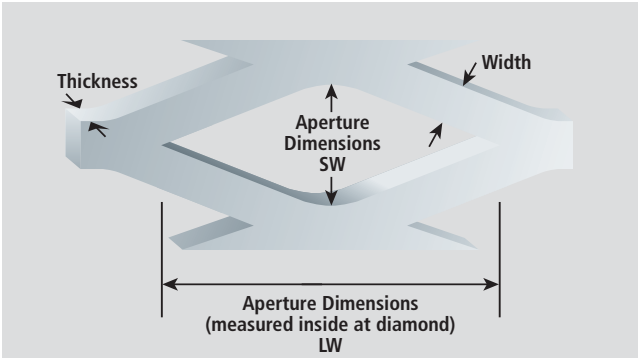

Reference No.	LW (mm)	SW (mm)	Width (mm)	Thickness After Flattening (mm)
0794F	14.22	4.83	1.85	0.96
1279F	23.11	5.84	3.20	1.52
1280F	24.38	7.11	2.39	1.14
1281F	24.38	7.87	2.06	1.47
1282F	24.38	7.62	2.08	1.14
1283F	25.15	8.64	1.65	0.94
1284F	24.38	9.40	1.22	1.14
1584F	32.77	10.92	3.18	1.50
1585F	33.53	12.45	2.34	1.14
2073F	42.93	14.22	4.60	2.69
2074F	39.12	18.29	4.72	2.74
2076F	43.43	18.03	2.31	1.14
2077F	43.18	17.27	3.23	1.45
2079F	43.94	18.80	2.36	1.45
2080F	42.93	20.32	1.73	1.45
2490F	45.00	17.00	6.00	3.70
2493F	52.07	20.32	2.29	1.45
3084F	68.83	28.70	2.83	1.45
3085F	66.55	30.23	2.03	1.45
3393F	77.47	27.18	6.53	2.82
3394F	69.84	37.08	5.49	2.16
3395F	76.96	32.77	3.81	1.85

FSS NEWCASTLE

TEL: 0191 499 0222

FAX: 0191 499 0223

EMAIL:

sales@franklinsteelplc.co.uk

FSS DUMFRIES

TEL: 01387 268 877

FAX: 01387 259 101

EMAIL:

dumfries@franklinsteelplc.co.uk

CSS WHITEHAVEN

TEL: 01946 63161

FAX: 01946 691 057

EMAIL:

cumbria@franklinsteelplc.co.uk

EXPANDED METAL – RAISED

CERTIFIED TO BRITISH / EU SPECIFICATIONS

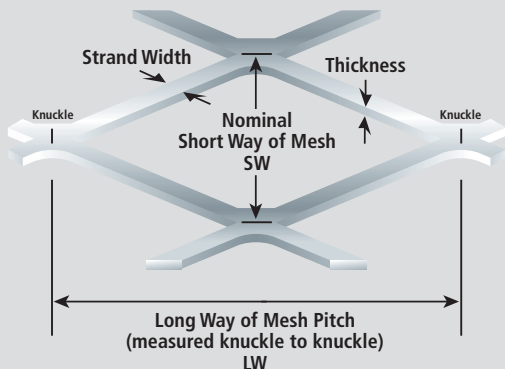

Reference No.	LW (mm)	SW (mm)	Width (mm)	Thickness (mm)
1292	30.48	12.70	4.75	2.50
1294	30.48	11.72	2.36	1.60
1295	30.48	11.72	1.98	1.60
1296	30.48	11.72	2.36	1.20
1298	30.48	11.72	1.63	1.00
1299	30.48	11.72	1.19	1.20
1576	38.10	16.93	4.75	3.00
1595	38.10	16.93	3.08	1.60
1597	38.10	16.48	2.25	1.60
1598	38.10	16.93	2.31	1.20
2088	50.80	22.58	3.89	3.00
2089	50.80	22.58	3.12	3.00
2091	50.80	22.58	2.52	2.50
2094	50.80	22.58	2.24	1.60
2096	50.80	22.58	2.34	1.20
2097	50.80	22.58	1.60	1.60
2499	60.96	24.38	2.16	1.60
3092	76.20	33.87	3.58	3.00
3396	85.73	40.64	3.18	3.00
4095	101.60	50.80	5.03	3.00
4595	114.30	40.64	9.47	4.50

FSS NEWCASTLE

TEL: 0191 499 0222

FAX: 0191 499 0223

EMAIL:

sales@franklinsteelpc.co.uk

FSS DUMFRIES

TEL: 01387 268 877

FAX: 01387 259 101

EMAIL:

dumfries@franklinsteelpc.co.uk

CSS WHITEHAVEN

TEL: 01946 63161

FAX: 01946 691 057

EMAIL:

cumbria@franklinsteelpc.co.uk

NON CARBON STEELS

CERTIFIED TO BRITISH / EU SPECIFICATIONS

We also have available a diverse range of non carbon steels including the following:

ALUMINIUM	CAST IRON
Angles Channel Flat Bar Open Mesh Flooring Hexagons Plate RHS Round Bar Sheet SHS Square Bar Tread Plate Tube	Round Bar Square Bar
	COPPER
	Flat Bar Round Bar Sheet Square Bar Strip Tube
	STAINLESS STEEL
	Angles Channel CHS Flanges Flat Bar Hexagons Plate Round Bar Sheet Square Bar
BRASS	
Flat Bar Hexagons Round Bar Sheet Square Bar	
BRONZE	
Sheet	

NON FERROUS

FSS NEWCASTLE

TEL: 0191 499 0222

FAX: 0191 499 0223

EMAIL:

sales@franklinsteelpc.co.uk

FSS DUMFRIES

TEL: 01387 268 877

FAX: 01387 259 101

EMAIL:

dumfries@franklinsteelpc.co.uk

CSS WHITEHAVEN

TEL: 01946 63161

FAX: 01946 691 057

EMAIL:

cumbria@franklinsteelpc.co.uk

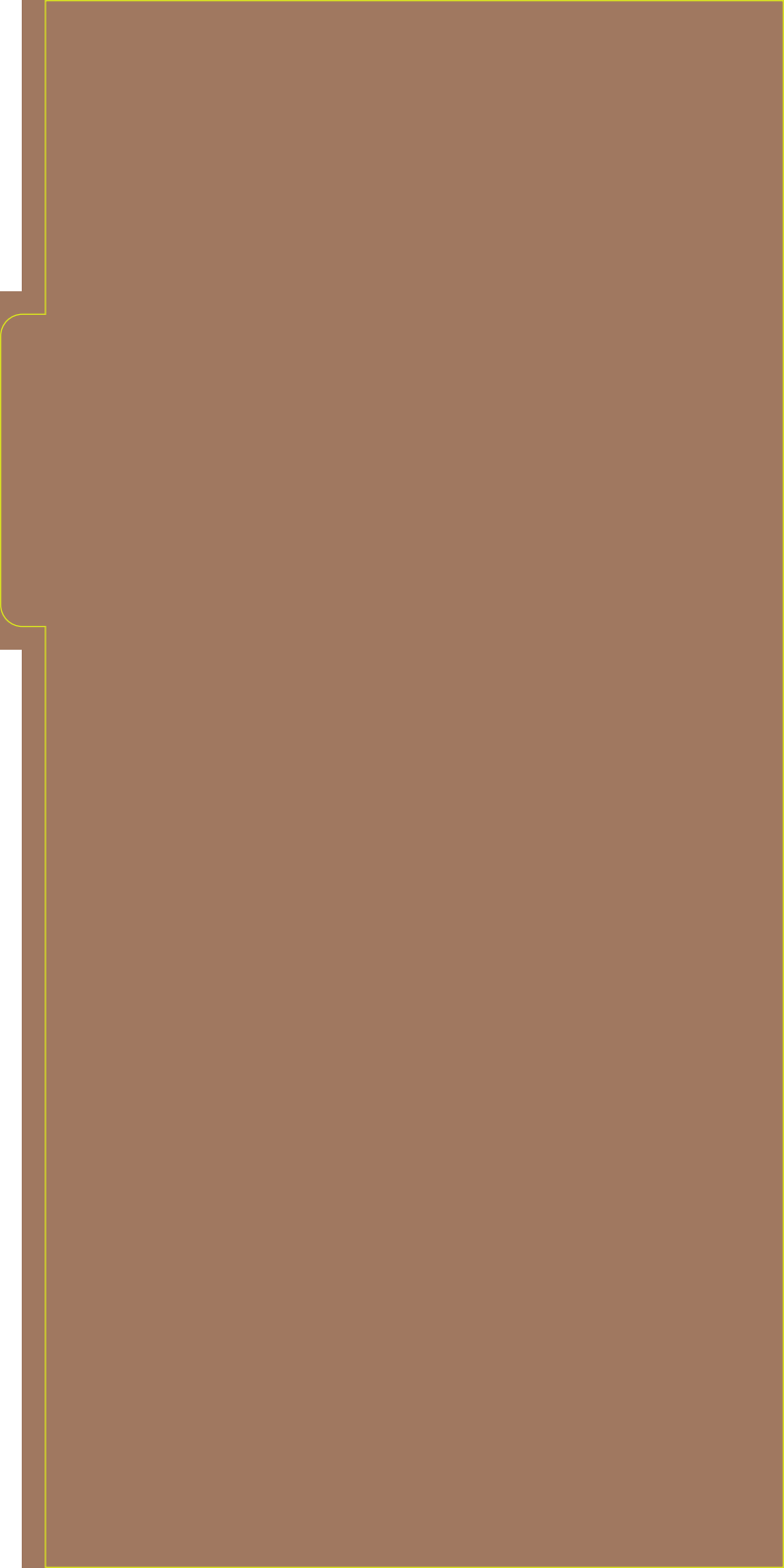

CONSUMABLES

ABRASIVES	ELECTRICAL (GENERAL)
Flap Discs Emory (rolls/sheets) Flexible Backing Pads Cutting Discs Grinding Discs Finishing Discs Velour Backed Discs Wire Brushes Router Cutters Files	Extension Leads Plugs Sockets Power Tools Lighting RCD
DRILLING (MASONRY)	FASTENERS
SDS Hammer Drills SDS Chisel Drills Straight Shank Drills K-Taper Drills A-Taper Drills Tile & Glass Drills	Wood Screws Machine Screws Self-Drilling Screws HEX Bolts Carriage Bolts Set Screws Socket Screws Eye Bolts U Bolts Hanger Bolts Self-Tapping Screws (Gimlet or Blunt Point) Nails (Round) Nails (Clout) Nails (Brad) Coach Bolts Screwed Rod Studding Rawl Bolts
DRILLING (METAL)	HEAD STYLES
Jobber Drills HSS Ground Long Series HSS Blacksmith Drills HSS Holecutters HSS Countersinks Cone Cutters HSS Hand Taps Screw Extractors Reamers Auger Bits	Flat Oval Pan Truss Round Hex Slotted Hex Allen
DRILLING (WOOD)	
SDS Shank Auger Bits Quad Wood Drills Flat Wood Bits Screw Countersinks Plug Cutters	

FSS NEWCASTLE

TEL: 0191 499 0222

FAX: 0191 499 0223

EMAIL:

sales@franklinsteelpc.co.uk

FSS DUMFRIES

TEL: 01387 268 877

FAX: 01387 259 101

EMAIL:

dumfries@franklinsteelpc.co.uk

CSS WHITEHAVEN

TEL: 01946 63161

FAX: 01946 691 057

EMAIL:

cumbria@franklinsteelpc.co.uk

CONSUMABLES

CERTIFIED TO BRITISH / EU SPECIFICATIONS

NUT TYPES	SCREWDRIVERS
Hex Nylon Insert Lock Wing Cap Acorn Flange Tee Square K-Lock Coupling	Cordless Power Insulated Ratchet PoziDrive Slotted Drywall
SAFETY ITEMS	WASHER TYPES
Hi-Vis Clothing Eye Protection Gloves/Gauntlets Hard Hats Respiratory Protection Faceshields Visors Coveralls Footwear Ear Plugs/Defenders	Flat Fender Split Lock Square Dock Finishing Spring Taper

FSS NEWCASTLE

TEL: 0191 499 0222
FAX: 0191 499 0223

EMAIL:

sales@franklinsteelpc.co.uk

FSS DUMFRIES

TEL: 01387 268 877
FAX: 01387 259 101

EMAIL:

dumfries@franklinsteelpc.co.uk

CSS WHITEHAVEN

TEL: 01946 63161
FAX: 01946 691 057

EMAIL:

cumbria@franklinsteelpc.co.uk

CONSUMABLES HAND TOOLS

HAMMERS	SPANNERS
Ball Pein Claw Deadblow Joiners Nylon Rubber Scaling	Metric Across Flats (AF) Box Open End Combination Ratchet Ring
POWER TOOLS	MISCELLANEOUS ITEMS
Angle Grinders SDS Drills Drills Sanders Nailers Impact Drivers Routers Planers Welding Equipment	Adhesive Tapes Cable Ties First-Aid Kits Warning Tape Hose Clips Trimmer Line Welding Rods Welding Masks Tape Measures Holesaws Spirit Levels Socket Sets Locks Trowels Sealants/Fillers Pliers
SAWS	
Circular Coping Drywall Fret Hacksaw Hand Mitre Tenon Tile	

FSS NEWCASTLE

TEL: 0191 499 0222

FAX: 0191 499 0223

EMAIL:

sales@franklinsteelpc.co.uk

FSS DUMFRIES

TEL: 01387 268 877

FAX: 01387 259 101

EMAIL:

dumfries@franklinsteelpc.co.uk

CSS WHITEHAVEN

TEL: 01946 63161

FAX: 01946 691 057

EMAIL:

cumbria@franklinsteelpc.co.uk

PARTNERS



Ambersil



DEWALT
GUARANTEED TOUGH.



evOLUTION



Garryson
Abrasives, Burrs & Routers



FSS NEWCASTLE

TEL: 0191 499 0222

FAX: 0191 499 0223

EMAIL:

sales@franklinsteelpc.co.uk

FSS DUMFRIES

TEL: 01387 268 877

FAX: 01387 259 101

EMAIL:

dumfries@franklinsteelpc.co.uk

CSS WHITEHAVEN

TEL: 01946 63161

FAX: 01946 691 057

EMAIL:

cumbria@franklinsteelpc.co.uk

PARTNERS



HITACHI
Inspire the Next

HONDA
Power
Equipment

IRWIN
Industrial Tools

JOBMAN
WORKWEAR

**KÄRCHER**

Makita



metabo

MIGATERONIC

MUREX

Panasonic

parweld
Tech Technology



RHODIUS
Qualitäts-Trennscheibe

FSS NEWCASTLE

TEL: 0191 499 0222

FAX: 0191 499 0223

EMAIL:

sales@franklinsteelplc.co.uk

FSS DUMFRIES

TEL: 01387 268 877

FAX: 01387 259 101

EMAIL:

dumfries@franklinsteelplc.co.uk

CSS WHITEHAVEN

TEL: 01946 63161

FAX: 01946 691 057

EMAIL:

cumbria@franklinsteelplc.co.uk

PARTNERS



FSS NEWCASTLE

TEL: 0191 499 0222

FAX: 0191 499 0223

EMAIL:

sales@franklinsteelpc.co.uk

FSS DUMFRIES

TEL: 01387 268 877

FAX: 01387 259 101

EMAIL:

dumfries@franklinsteelpc.co.uk

CSS WHITEHAVEN

TEL: 01946 63161

FAX: 01946 691 057

EMAIL:

cumbria@franklinsteelpc.co.uk

GENERAL INFORMATION

CERTIFIED TO BRITISH / EU SPECIFICATIONS

STANDARD WIRE GAUGE

S.W.G.	Thickness (mm)
4	5.892
5	5.384
6	4.876
7	4.470
8	4.064
9	3.657
10	3.251
11	2.946
12	2.640
13	2.336
14	2.032
15	1.828
16	1.625
17	1.422
18	1.219
19	1.016
20	0.914
21	0.812
22	0.711
23	0.609
24	0.558
25	0.508
26	0.457
27	0.416
28	0.375
29	0.345
30	0.314

TECHNICAL DATA

FSS NEWCASTLE

TEL: 0191 499 0222

FAX: 0191 499 0223

EMAIL:

sales@franklinsteelpc.co.uk

FSS DUMFRIES

TEL: 01387 268 877

FAX: 01387 259 101

EMAIL:

dumfries@franklinsteelpc.co.uk

CSS WHITEHAVEN

TEL: 01946 63161

FAX: 01946 691 057

EMAIL:

cumbria@franklinsteelpc.co.uk

COMPARISON BETWEEN GRADES

(BS EN 10025 PART 2: 2004 & PREVIOUS GRADES)

BS EN 10025 : PART 2 : 2004						BS EN 10025 : 1993	BS 4360 : 1990
Grade	Yield (Rel) min	Tensile (Rm)	Charpy V-notch longitudinal		Grade	Grade	
			Temp (degrees C)	Energy (J) t = 16mm (MPa)			
S185	185	290/510	-	-	S185	-	
WITHDRAWN			-	-	S235	40A	
S235JR	235	360/510	20	27	S235JR/G1/G2	40B	
S235J0	235	360/510	0	27	S235J0	40C	
S235J2	235	360/510	-20	27	S235J2G3/G4	40D	
WITHDRAWN			-	-	S275	43A	
S275JR	275	410/560	20	27	S275JR	43B	
S275J0	275	410/560	0	27	S275J0	43C	
S275J2	275	410/560	-20	27	S275J2G3/G4	43D	
WITHDRAWN			-	-	S355	50A	
S355JR	355	470/630	20	27	S355JR	50B	
S355J0	355	470/630	0	27	S355J0	50C	
S355J2	355	470/630	-20	27	S355J2G3/G4	50D	
S355K2	355	470/630	-20	40	S355J2G3/G4	50DD	
E295	295	470/610	-	-	E295	-	
S335	335	570/710	-	-	S335	-	
E360	360	650/830	-	-	E360	-	

FSS NEWCASTLE

TEL: 0191 499 0222
FAX: 0191 499 0223

EMAIL:

sales@franklinsteelpc.co.uk

FSS DUMFRIES

TEL: 01387 268 877
FAX: 01387 259 101

EMAIL:

dumfries@franklinsteelpc.co.uk

CSS WHITEHAVEN

TEL: 01946 63161
FAX: 01946 691 057

EMAIL:

cumbria@franklinsteelpc.co.uk

CONDITIONS OF SALE

- 1 All sales contracts of Franklin Steel Stockholders plc (hereinafter referred to as 'the Company') shall be deemed to incorporate these Conditions except insofar as these Conditions are varied by any special conditions agreed in writing between the parties and signed by a Director of the Company. Any terms and conditions in the Buyers order which are inconsistent with these conditions shall have no effect.
- 2 The Company shall not be liable for delay in delivery or failure to make delivery of any goods due to circumstances beyond its control, including but without prejudice to the generality of the foregoing war, rebellion, revolution, strikes, lock-outs, breakdowns of plant or governmental or other laws, regulations or decrees.
- 3 Until such time as all sums due to the Company from the Buyer whether in respect of goods delivered by the Company to the Buyer or otherwise have been paid the provisions of this condition shall have effect.
 - (a) All goods delivered by the Company to the Buyer will remain the property of the Company to the intent that the whole legal and beneficial interest therein shall remain that of the Company.
 - (b) If the Buyer becomes insolvent or being a body corporate has a Receiver appointed or passes a resolution for winding up or if a court makes an order to that effect or being an individual or partnership makes any composition or arrangement with his or their creditors or has a receiving order made against him or them or if the Buyer shall be in breach of these Conditions then the Company shall be at liberty to forthwith remove and repossess all goods which remain the property of the Company in accordance with this Condition.
 - (c) No provision of this Condition shall be deemed to cause any Mortgage or Charge of the property or undertaking of the Buyer or any part thereto to have been created by the Buyer in favour of the Company.
- 4 Unless fixed prices have been agreed by the Company the price payable by the Buyer shall be the Company's ruling price at the date of despatch or delivery. Prices include delivery unless otherwise stated and are subject to the addition of VAT. Payment is due in net cash by the end of the month following the month of delivery.
- 5 Delivery shall be deemed to be effective and the risks in the goods shall pass from the Company to the Buyer when the goods are unloaded at the address nominated by the Buyer or his agent for delivery save where goods are to be collected by the Buyer or his Agent when the goods are loaded onto vehicle collecting them.
- 6 Dates or periods of delivery stated in the contract are approximate only and time shall not be of the essence of the contract.
7. No claim for material damage in transit will be considered by the Company unless:-
 - (a) an appropriately qualified signature e.g. Material received damaged (signed) is clearly made by the customer on the delivery note and
 - (b) the Company is advised in writing, in addition to (a) above within two days of receipt of material. No allowance for short weight will be made unless the Company is given an opportunity for verifying the same within three days.
8. The Company warrants that the goods are within usual mill tolerances as to the quality and finish and will replace or refund the price of any goods which do not comply with this warranty. As the Company is generally unaware of the use to which its goods will be put all conditions and warranties as to fitness for purposes whether express or implied and whether arising by statute, custom of the trade or at common law are excluded. The Company shall not be liable for loss of profit, damage to plant or for any consequential or special loss or damage sustained by the Buyer as a result of any breach of contract by the Company.

FSS NEWCASTLE

TEL: 0191 499 0222

FAX: 0191 499 0223

EMAIL:

sales@franklinsteelplc.co.uk

FSS DUMFRIES

TEL: 01387 268 877

FAX: 01387 259 101

EMAIL:

dumfries@franklinsteelplc.co.uk

CSS WHITEHAVEN

TEL: 01946 63161

FAX: 01946 691 057

EMAIL:

cumbria@franklinsteelplc.co.uk

CONDITIONS OF SALE

9. The Company shall not be required to supply test certificates unless the same are requested a reasonable time before delivery and the Company may charge a reasonable fee for any certificate supplied.
10. The Buyer shall not be entitled to withhold payment of any sums due to the Company by reason of any disputed claim of the Buyer for defective goods or alleged breach of contract by the Company.
11. Without prejudice to any of its other rights the Company may terminate the contract or suspend further deliveries to the Buyer in the event of the Buyer failing to make due payment for any goods or if any distress execution or other legal process shall be levied upon the Buyer or if the Buyer becomes insolvent or being a body corporate has passed a Resolution for voluntary winding - up or is subject to a winding - up Order of the Court or has had a Receiver appointed.
12. The contract between the and the Buyer shall be deemed to have been made in England and shall be governed in all respects by English law. The Buyer shall submit to the jurisdiction of the English courts.

FSS NEWCASTLE

TEL: 0191 499 0222
FAX: 0191 499 0223

EMAIL:
sales@franklinsteelpc.co.uk

FSS DUMFRIES

TEL: 01387 268 877
FAX: 01387 259 101

EMAIL:
dumfries@franklinsteelpc.co.uk

CSS WHITEHAVEN

TEL: 01946 63161
FAX: 01946 691 057

EMAIL:
cumbria@franklinsteelpc.co.uk

NEWCASTLE

Franklin Steel plc
Patterson Street • Blaydon Haugh
Newcastle upon Tyne • Tyne & Wear • NE21 5TL

EMAIL: sales@franklinsteelplc.co.uk

TEL: 0191 499 0222

FAX: 0191 499 0223

DUMFRIES

Franklin Steel plc (Dumfries)
Dumfries Enterprise Park • Tinwald Downs Road
Heathhall • Dumfries • DG1 3SJ

EMAIL: dumfries@franklinsteelplc.co.uk

TEL: 01387 268 877

FAX: 01387 259 101

WHITEHAVEN

FSS plc T/A Cumbria Steelstock
William Pit Industrial Estate • Whitehaven
Cumbria • CA28 6AU

EMAIL: cumbria@franklinsteelplc.co.uk

TEL: 01946 63161

FAX: 01946 691 057

www.franklinsteelplc.co.uk